

NON
NON
NON

General Catalog
2022



JUKI CORPORATION
SEWING MACHINERY & SYSTEMS BUSINESS UNIT

2-11-1, TSURUMAKI, TAMA-SHI,
TOKYO 206-8551, JAPAN
PHONE: (81) 42-357-2383
FAX: (81) 42-357-2274
<https://www.juki.co.jp/en>

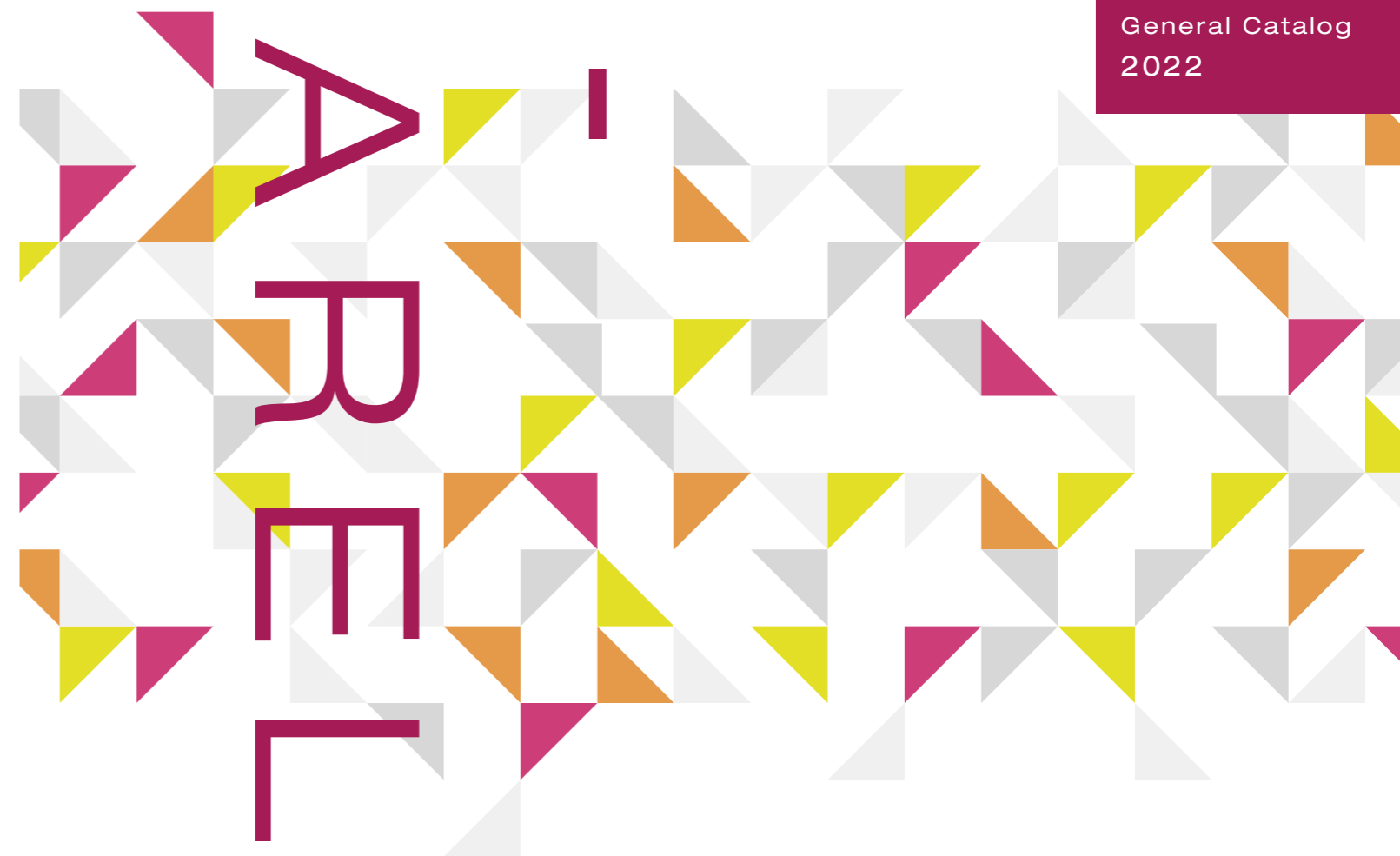

Registered Organization:
JUKI CORPORATION Head Office
The Scope of the Registration: The activities
of research, development, design, sales,
distribution, and maintenance services of
industrial sewing machines, household
sewing machines and industrial robots, etc.,
including sales and maintenance services of
data entry systems.

* Specifications and appearance are subject to change without prior notice for improvement.
* Read the instruction manual before putting the machine into service to ensure safety.
* This catalogue prints with environment-friendly soyink on recycle paper.
* Paper from responsible sources **FSC™ C001712**

FEBRUARY, 2022 Printed in Japan(TN)

JUKI Smart Solutions
Innovation with our Best Global Support

Let's start a SMART FACTORY with JUKI!

Sewing factories all over the world are seriously short of labor.

The key, in planning for future growth, is to steadily improve productivity even as the labor force dwindles. Simply put, the productivity per worker must get better than ever.

In JUKI's SMART FACTORY, advanced sewing machines, IoT technology, and years of experience in sewing factory efficiency come together to improve the productivity of every single worker.

Visualized



Connected



JUKI's proposal for a SMART FACTORY

The combination of various automated facilities and digitalized general-purpose sewing machines improve operation availability. Production time, which used to be manpower-dependent, is much reduced as a result. Production efficiency, meanwhile, is maximized by visualizing data on operation availability through networked production facilities.

NETWORKING

Visualize machine operation availability



DIGITALIZATION

Much less downtime,
No more dependence
on worker skills



AUTOMATIZATION

Better productivity,
Better quality,
Lower labor costs

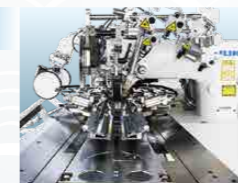

SHOP IMPROVEMENTS

Consulting service
based on data



Take the 1st step

forward together with JUKI!

DIGITALLY ***Smart Solution***

Inspire the Knowledge in Sewing Adjustment **Epoch-making Sewing Systems in history**

Digitalization of sewing machines redefines the traditional reliance of skilled and experienced veterans in the sewing factory.

Realization of digitalization and IoT technology also introduces new possibilities to the improvement of bottleneck quality, reproduction of optimum tension controls, and optimize time required for setup and maintenance processes.

Creation of exquisite seam

Digitalization of feeding locus^{*1}, needle thread tension etc. with JUKI developed innovative technology. With numerical representation of sewing variables, parameter adjustments are made simplified while improvising efficiency and quality.

Reproduction of sewing with IoT

While sewing adjustment data are stored within the machine, the information can be extracted by using an Android terminal^{*2} or USB device. Realizes requests such as [Wanting to reproduce seam quality from previous adjustments], [Wish to allow other machine to exact the same sewing quality as each other].

Visualization of production activities

Digitalization is not limited for adjustments of parameter data. JUKI Smart APP^{*3} allows users to view the output and operation ratio etc. of individual machines in graph format. Promoting analysis and problem solving based on the actual conditions.

^{*1} DDL-9000C, LZ-2290C

^{*2} The sewing machine can be paired with equipment which supports NFC (Near Field Communication) only by holding the equipment over the sewing machine.

^{*3} Android OS Version 6.0 is recommended to use JUKI Smart APP. (Operation is confirmed with respect to Versions 5.0 and later.)
Contact JUKI distributor in your area for how to use the application software.



LINE UP



Semi-dry Direct-drive, Unison-feed, Lockstitch Sewing System with automatic thread trimmer

LU-2800V-7



Semi-dry Direct-drive, Post-bed, Unison-feed, Lockstitch Sewing System with Vertical-axis Large Hook

PLC-2700V-7



Computer-controlled Cycle Machine with Input Function

AMS-221F



Computer-controlled, High-speed, Bartacking Sewing System

LK-1900BN



Computer-controlled, High-speed, Buttonholing Sewing System

LBH-1790AN

Pictographs for Function

Needle	Feed	Stitch shape
2-needle	Bottom-feed	Zigzag stitching
Organized split needle bar	Needle-feed	Lockstitch buttonholing
Hook	Differential-feed	Shorter-thread remaining functions
Horizontal-axis hook (large)	Top and bottom-feed	shoelace loop attaching
Horizontal-axis hook (3 fold-capacity)	Unison-feed	Function
Vertical-axis hook (large)	X-Y drive	Active tension
Vertical-axis hook (extra large)	R-θ drive	Automatic thread trimmer
	Alternating foot stroke adjusting dial	Cloth cutting knife
Dry-head, Intelligent Direct-drive Sewing Machine	Digitally Smart Solution	

*sti/min is the abbreviation for "stitches per minute"

Applications



CONTENTS

Catalog of each model is also available.
For further details, please refer to each catalog.

Flat-bed Sewing Machine

DDL-8700L	01
DDL-5600N-7, 5600N	
DU-1481-7	
DU-1181N-7/X73096, 1181N	02
DU-141H-7, 140U	
DNU-1541-7, 1541S, 1541	
DNU-1541-7-0BB/X55270, 1541/X55245	03
DNU-1541/X55247	
LU-1508N, 1509N	
LU-1510N-7, 1510N, 1511N-7	04
LU-1510NA-7	
LU-1510NA-7/X55500	
LU-1520NCS-7	05
LU-1560N-7, 1560N, 1561N-7, 1561N, 1565N	
LU-2828V-7, 2860V-7 DIGITALLY	06
LU-2810-7, 2810	
LU-2810V-7/X73235 DIGITALLY	07
LU-2860-7, 2860	
LU-2818AL-7, 2868AL-7	
LU-2828A-7	08
LU-2810ESAL-7, 2818ESAL-7, 2828ESA-7	
LU-2810A-7/X73178	
LU-2210N-7, LU-2210W-7, LU-2212N-7, LU-2220N-7	09
LU-2260N-7, 2260W-7	
LZH-1290-7, 1290	

Cylinder-bed Sewing Machine

DSU-142-7, 145-7, 142U, 145U	10
DSC-244U, 245U, 246U, 245-7, 246-7	
DSC-245-7-0B/X55167, 245U/X55200, 245U/X55278	
LS-2342-7, LS-2342	11
LS-1342-7, 1342, 1341, 1340	
LS-1341/X55287	
LS-1342-7-0BB/X55275, 1342/X55274, 1342/X55280	12

Post-bed Sewing Machine

PLC-2710V-7, 2760V-7 DIGITALLY	13
PLC-2710-7, 2710	
PLC-2760-7, 2760, 2760L, 2765	14
PLC-1710-7, 1710	
PLC-1760-7, 1760, 1760L	15
PLC-1690, 1691	
PLH-981U, 982U, PLN-985U	

Long Arm Sewing Machine

LU-2216N-7, 2266N-7	16
LG-158-1U, 158U	
TSC-461U	

Flat-bed Sewing Machine for Extra Heavy-weight Materials

TNU-243U, TU-273U	17
-------------------	----

Cylinder-bed Sewing Machine for Extra Heavy-weight Materials

TSH-411U, TSN-421U, TSC-441U, TSU-471U	17
--	----

Bartacking Machine

LK-1900BN-HS, 1900BN-WS DIGITALLY	18
--	----

Shape-tacking Machine

LK-1910, 1920	18
---------------	----

Computer-controlled Cycle Machine

AMS-251, AMS-252/X77026	19
AMS-224EN-4530R/AW-3, 6030R/AW-3	
AMS-224EN-4530R	20
AMS-221F-3020R/AW-3, AMS-221F-3020R DIGITALLY	
AMS-221F-2516, 3020 DIGITALLY	21
AMS-210EN-1306, 1510, 2210, AMS-221EN-2516, 3020	22
AMS-210EN-ZL1510RZC/X90022, X90023, X90030	23
AMS-224EN-4530, 6030, AMS-224ENHC10050	
AMS-224EN-4530/X7910, AMS-224EN-6030/X7910, AMS-224ENHC10050/X7970	
AMS-224EN-6060	24
AMS-210EN-HL1306/7300	
AMS-210EN-HL2210/TF10S	
AMS-221EN-TS3020	25
AW-3S	

Automatic Machine

AB-1360/CR-10A	25
AB-1360	26
PS-800-13085, 12080, 8045, 6045	
PS-800HB-8045ZKZ/X88009	

Others

MO-6900G Series	27
LBH-1790AN Series DIGITALLY	

Motor / Software / System

SC-920/M51N Series	28
PM-1	
JaNets JT Simple	29
JUKI-ShuHaRi	31
JUKI e-learning	32

Option Parts

Plastic Bobbin	33
LK-1900 Shorter Thread remaining Kit	
LK-1900 Instant Button Sewing Clamp Kit	34

Flat-bed Sewing Machine

1-needle, Lockstitch Machine

DDL-8700L

This is a newly designed JUKI's unique lockstitch machine. The machine is able to sew at a pitch as long as 7mm for both normal and reverse feed directions.

With the adoption of a feed mechanism and thread take-up lever, the machine achieves increased efficiency of feed and well-tensed stitches. It is a basic lockstitch machine suited for sewing leather or heavy materials such as bags, pouches and purses.

Model name	DDL-8700L
Max. sewing speed	4,000sti/min
Max. stitch length	7mm
Presser foot	By knee: 13mm
Needle	DBx1 #16~#23
Thread	#40~#8, B33~B92, Nm=90/3~30/3



DDL-8700L

1-needle, Lockstitch Machine with Double-capacity Hook

DDL-5600N-7 DDL-5600N

The machine is capable of making well-tensed, beautifully finished seams, regardless of the type of heavy materials.

Model name	DDL-5600N-7, 5600NL
Max. sewing speed	3,000sti/min
Max. stitch length	8mm
Presser foot	By knee: 13mm
Needle	DBx1 (#21) #20~#23
Thread	#30~#8, B46~B92, Nm=60/3~30/3



DDL-5600N-7

Direct-drive, 1-needle, Top and Bottom-feed, Lockstitch Machine with Double-capacity Hook with Automatic Thread Trimmer

DU-1481-7

This sewing machine is provided with a high-torque direct-drive motor that supports heavy-weight materials. The machine achieves a longer distance from machine arm to needle by adopting a high long arm. The DU-1481-7 is suited to the sewing and decorative shape-tacking of heavy-weight materials such as car seats, sofas, bags and stroller.

Model name	DU-1481-7
Max. sewing speed	2,200sti/min
Max. stitch length	9mm (forward / backward)
Lift of the presser foot	By hand: 7mm, By knee: 16mm
Alternating vertical movement	2~5.5mm
Needle	DPx17 #23(#18~#24)
Thread	#30~#8
Distance from needle to machine arm	335mmx150mm



DU-1481-7

1-needle, Top and Bottom-feed, Lockstitch Machine with Double-capacity Hook

DU-1181N-7/X73096 DU-1181N

With its strong top and bottom feed mechanism, the machine insures the smooth feeding of hard-to-feed materials or multi-layered sections of materials to achieve consistent seam quality that is free from irregular stitch pitches. The automatic lubricating mechanism dramatically improves maintainability of the machine.

Model name	DU-1181N-7/X73096	DU-1181N
Max. sewing speed	2,000sti/min	
Max. stitch length	9mm	
Presser foot	By knee: 15mm	
Alternating vertical movement	2~5mm	
Needle	DPx17 (#21) #14~#23	
Thread	#40~#8, B33~B92, Nm=90/3~30/3	

*DU-1181N-7/X73096 is available on a custom order. Contact JUKI for how to place an order.



DU-1181N

1-needle, Top and Bottom-feed, Lockstitch Machine

DU-141H-7 (with double-capacity hook) DU-140U

The basic sewing machine equipped to sew heavy-weight materials promises consistent seam quality and outstanding operability.

Model name	DU-141H-7	DU-140U
Max. sewing speed	2,000sti/min	
Max. stitch length	9mm	
Presser foot	By knee: 15mm	
Alternating vertical movement	2~5mm	
Needle	DBx1 (#21) #14~#23	
Thread	#40~#8, B33~B92, Nm=90/3~30/3	



DU-141H-7

1-needle, Unison-feed, Lockstitch Machine with Double-capacity Hook

DNU-1541-7 DNU-1541S (with safety mechanism) DNU-1541

With its larger needlebar stroke, higher presser foot lift, and newly adopted double-tension mechanism, the machine offers excellent sewing capabilities and responsiveness. The machine's rectangular feeding motion promises the consistent feeding of materials of all thicknesses without stitch gathering.

Model name	DNU-1541-7	DNU-1541S, 1541
Max. sewing speed	3,000sti/min	2,500sti/min
Max. stitch length	9mm	
Presser foot	By knee: 16mm	
Alternating vertical movement	1~6.5mm	2.5~6.5mm
Needle	135x17 (Nm160) Nm125~Nm180	
Thread	#30~#5, B46~B138, Nm=60/3~15/3	



DNU-1541-7

Flat-bed Sewing Machine

Flat-bed Sewing Machine

1-needle, Unison-feed, Lockstitch Machine with Double-capacity Hook

DNU-1541-7-0BB/X55270 (for container bag) 

DNU-1541/X55245 (for thick thread) 

DNU-1541/X55245 is able to sew a broad range of materials from genuine leather materials to lining materials. Excellent seam tightness on genuine leather and far less puckering on lining.

DNU-1541-7-0BB/X55270 is provided as standard with an external bobbin winder for supplying the large amount of thread required to sew a container bag.

Model name	DNU-1541-7-0BB/X55270	DNU-1541/X55245
Max. sewing speed	2,000sti/min	
Max. stitch length	9mm	
Needle bar stroke	36mm	38mm
Needle	134x17(Nm200) Nm125~Nm200	134x17(Nm160) Nm125~Nm160
Thread	#30~#5, B46~B138, Nm=60/3~20/3	#20~#0, B46~B207, Nm=40/3~15/3



DNU-1541/X55245

1-needle, Needle-feed, Lockstitch Machine with Double-capacity Hook

DNU-1541/X55247 (for thick thread)  

The machine is created by converting the standard machine into a needle-feed mechanism, and with new rectangular feed which helps reduce gathered stitches, it offers excellent responsiveness to the sewing of thick thread (Needle thread #1/Bobbin thread #1). The machine is best-suited for sewing such as thick thread decorative stitches on jeans.

Model name	DNU-1541/X55247
Max. sewing speed	2,500sti/min
Max. stitch length	7mm
Needle bar stroke	36mm
Needle	134x17 (Nm160) Nm125~Nm180
Thread	#30~#1, B46~B207, Nm=60/3~15/3



DNU-1541/X55247

1-needle, Unison-feed, Lockstitch Machine with Vertical-axis Large Hook

LU-1508N (standard gauge) 

LU-1509N (gauge for europe) 

The maximum stitch length is 10mm. The complete rectangular feed locus enables accurate feed of extra heavy materials while preventing stitch gathering. With its sufficient needlebar stroke of 38mm and long 190R needle, the machine supports the sewing of extra heavy materials. The machine comes with an extra large steel handwheel with a diameter as large as $\phi 175$.

Model name	LU-1508NS, 1509NS	LU-1508NH, 1509NH
Application	Heavy-weight	Extra heavy-weight
Max. sewing speed	2,500sti/min	2,000sti/min
Max. stitch length	9mm	10mm
Presser foot	By knee: 16mm	
Alternating vertical movement	2.5~6.5mm	
Needle	190(R) or 135x17 (Nm160) Nm125~Nm180	
Thread	#30~#5, B46~B138, Nm=60/3~20/3	#20~#1, B69~B207, Nm=40/3~8/3



LU-1508N

Flat-bed Sewing Machine

1-needle, Unison-feed, Lockstitch Machine with Vertical-axis Large Hook

LU-1510N-7 (standard gauge) 

LU-1510N (standard gauge)

LU-1511N-7 (gauge for europe) 

This one-needle machine with a thread trimmer utilizes a basic performance which matches best to the sewing of medium to heavy materials. The machine's rectangular feeding motion promises the consistent feeding of materials of all thicknesses without stitch gathering.

Model name	LU-1510N-7, 1511N-7	LU-1510N
Max. sewing speed	3,000sti/min	2,500sti/min
Max. stitch length	9mm	
Presser foot	Auto: 16mm	By knee: 16mm
Alternating vertical movement	1~6.5mm	2.5~6.5mm
Needle	135x17 (Nm160) Nm125~Nm180	
Thread	#30~#5, B46~B138, Nm=60/3~20/3	



★ 5-way switch is an option.

LU-1510N-7

1-needle, Unison-feed, Lockstitch, Machine with Vertical-axis Large Hook

LU-1510NA-7 (for sewing car seats) 

The machine demonstrates sewing capabilities best suited for sewing car seats of light- to heavy-weight materials without using any additional devices.

The machine prevents fabric yarn breakage when using a thin needle. The machine is able to perform low-tension sewing where less a load is applied to the material.

Model name	LU-1510NA-7
Max. sewing speed	2,000sti/min
Max. stitch length	7mm
Presser foot	Auto: 16mm
Alternating vertical movement	1~6.5mm
Needle	135x17 (Nm120) Nm100~Nm160
Thread	TEX 50~135



★ 5-way switch is an option.

LU-1510NA-7

1-needle, Unison-feed, Lockstitch Machine with Vertical-axis Large Hook

LU-1510NA-7/X55500 (for sewing car seats) 

Best-suited for plants manufacturing car seats. Beautifully finished seams are produced by increasing the feed efficiency.

Model name	LU-1510NA-7/X55500
Max. sewing speed	2,000sti/min
Max. stitch length	7mm
Presser foot	By hand: 9mm, By knee: 16mm
Alternating vertical movement	1~6.5mm
Needle	135x17 (Nm120) Nm100~Nm160
Thread	#30~#5, B46~B138, Nm=60/3~20/3



LU-1510NA-7/X55500

Flat-bed Sewing Machine

1-needle, Unison-feed, Lockstitch Machine with Vertical-axis Large Hook

LU-1520NCS-7

(with a shorter-thread remaining type thread trimmer)

This model of sewing machine is a straight knife with a shorter-thread remaining type thread trimmer. It is based on the tried-and-trusted LU-1510NA-7 Series and achieves the best-suited seam quality for sewing car seats. In addition, thread nipping process which has been conventionally required at the end of sewing is no longer required, thereby eliminating concern about damages on sewn products by scissors.

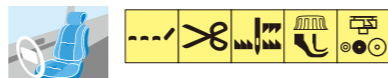

LU-1520NCS-7

Model name	LU-1520NCS-7
Max. sewing speed	2,000sti/min
Max. stitch length	7 mm (normal/reverse feed)
Presser foot	By hand: 9mm, Auto: 16mm
Alternating vertical movement	1~6.5mm
Needle	135x17(Nm120) Nm100~Nm160
Thread	#30~#5

2-needle, Unison-feed, Lockstitch Machine with Vertical-axis Large Hooks

LU-1560N-7 (standard gauge)



LU-1560N (standard gauge)

LU-1561N-7 (gauge for europe)



LU-1561N (gauge for europe)

LU-1565N (with organized split needle bar)



The two-needle machine with a thread trimmer offers basic performance that is ideally suited to sewing heavy materials. The machine utilizes a new mechanism that does not change the ratio of the alternate vertical movement of the walking foot and presser foot, even when the material thickness changes. The mechanism helps prevent slippage between the upper and lower materials even when a heavy material is used.



*5-way switch is an option.

LU-1560N-7

Model name	LU-1560N-7, 1561N-7	LU-1560N, 1561N	LU-1565N
Max. sewing speed	2,500sti/min		2,000sti/min
Max. stitch length	9mm		
Presser foot	Auto: 16mm	By knee: 16mm	By knee: 13mm
Alternating vertical movement	1~6.5mm	2.5~6.5mm	
Needle	135x17 (Nm160) Nm125~Nm180		
Thread	#30~#5, B46~B138, Nm=60/3~20/3		

Flat-bed Sewing Machine

Semi-dry Direct-drive, Unison-feed, Lockstitch Sewing System with automatic thread trimmer



LU-2828V-7

(1-needle, Vertical axis 2.7 fold-capacity hook / Shorter - thread remaining type)

LU-2860V-7

(2-needle, Vertical axis 2.0 fold-capacity hook)



This model digitalizes adjustment values required for sewing and easily transfers them to the main body of sewing machine by means of the ICT. This sewing system is the flag ship model of sewing machines that are specifically developed for sewing heavy-weight materials for car seats and sofas such as leather, artificial leather and heavy-weight fabric. Five adjustment values (stitch length, presser foot height, pressure foot pressure, alternate vertical movement amount of the walking foot and needle thread tension) required for sewing are digitalized.



LU-2828V-7

Management, browsing and editing of data can be carried out on the application software

A "Two-way" contactless communication for parameter adjustment data can be conducted with the sewing machine by a commercial Android terminal. This feature allows sewing machines in a sewing line to be uniformly set and status checked quickly, thereby contributing to stabilization in product quality. Control panel is standardized with USB ports, promising simplicity in data management and system updates.



*Android OS Version 6.0 is recommended to use JUKI Smart APP. (Operation is confirmed with respect to Versions 5.0 and later.) Contact JUKI distributor in your area for how to use the application software.

The sewing machine can be paired with equipment which supports NFC (Near Field Communication) only by holding the equipment over the sewing machine.

Model name	LU-2828V-7	LU-2860V-7
Max. sewing speed	3,500sti/min	
Gauge	A : Gauge for europe	
Max. stitch length	9mm	12mm
Presser foot	20mm	
Alternating vertical movement (DL)	9mm	
Needle	134x35 (Nm140) Nm125~NM180	134x35 (Nm160) Nm125~Nm200
Thread	#30~#5	

Semi-dry Direct-drive, 1-needle, Unison-feed, Lockstitch Machine with Vertical-axis Large Hook

LU-2810-7 (2.0 fold-capacity hook, 2-pitch dial)



LU-2810 (2.0 fold-capacity hook)



High and long arm has been adopted. The machine is suited to the sewing of car seats, sofas and bags. It is a sewing machine provided with dramatically improved workability and functions which are required for sewing large products and extra heavy-weight materials.

Model name	LU-2810-7	LU-2810
Max. sewing speed	3,000sti/min	
Gauge	S: Standard gauge, A: Gauge for europe	
Max. stitch length	9mm	
Presser foot	By hand: 10mm, Auto: 20mm	By knee: 20mm
Alternating vertical movement	1~9mm	
Needle	135x17 (Nm160) Nm125~Nm180	
Thread	#30~#5, B46~B138, Nm=60/3~20/3	



LU-2810-7

Flat-bed Sewing Machine

Semi-dry Direct-drive, 1-needle, Vertical-axis 2.0 Fold-Capacity Hook with automatic thread trimmer

LU-2810V-7/X73235

This sewing machine is a double hook type digital sewing machine based on LU-2810-7. Like the LU-2800-7 series, It uses a high and long arm. The machine is suited to the sewing of car seats, sofas and bags. It is a sewing machine provided with dramatically improved workability and functions which are required for sewing large products and extra heavy-weight materials.





LU-2810V-7/X73235

Model name	LU-2810V-7/X73235
Max. sewing speed	3,000sti/min
Gauge	A: Gauge for europe
Max. stitch length	9mm
Presser foot	By hand: 10mm, Auto: 20mm
Alternating vertical movement	1~9mm
Needle	135x17 (Nm160) Nm125~Nm180
Thread	#30~#5, B46~B138, Nm=60/3~20/3

Semi-dry Direct-drive 2-needle, Unison-feed, Lockstitch Machine with Vertical-axis Large Hooks

LU-2860-7

(2.0 fold-capacity hook, 2-pitch dial)  

LU-2860 (2.0 fold-capacity hook)

High and long arm has been adopted. The machine is suited to the sewing of car seats, sofas and bags. It is a sewing machine provided with dramatically improved workability and functions which are required for sewing large products and extra heavy-weight materials.



LU-2860

Model name	LU-2860-7	LU-2860
Max. sewing speed	2,700sti/min	
Gauge	S: Standard gauge, A: Gauge for europe	
Max. stitch length	9mm	
Presser foot	By hand: 10mm, Auto: 20mm	By knee: 20mm
Alternating vertical movement	1~9mm	
Needle	135x17 (Nm160) Nm125~Nm180	
Thread	#30~#5, B46~B138, Nm=60/3~20/3	

Semi-dry Direct-drive, Unison-feed, Lockstitch Machine with Vertical-axis Large Hook (2.7 fold-capacity hook, 2-pitch dial, long-pitch type)

LU-2818AL-7 (1-needle)

LU-2868AL-7 (2-needle)

This model is the most-desired sewing machine for sewing furniture such as sofas. It is best-suited to topstitching with a long stitch pitch. During the topstitching process, the longer distance from the machine arm to the bed, in particular, effectively demonstrates the machine's improved workability.



LU-2868AL-7

Model name	LU-2818AL-7	LU-2868AL-7
Max. sewing speed	3,000sti/min	2,700sti/min
Gauge	A: Gauge for europe	
Max. stitch length	12mm	
Presser foot	By hand: 10mm, Auto: 20mm	
Alternating vertical movement	1~9mm	
Needle	135x17 (Nm160)Nm125~Nm180	
Thread	#30~#5, B46~B138, Nm=60/3~20/3	

Flat-bed Sewing Machine

Semi-dry Direct-drive, 1-needle, Unison-feed, Lockstitch Machine with Vertical-axis Large Hook

LU-2828A-7

(2.7 fold-capacity hook, 2-pitch dial, needle thread roll-in and shorter-thread remaining type)

The shorter-thread remaining type LU-2828A-7 is a high-performance sewing machine. It leaves a shorter thread on the material at the beginning of sewing by means of the needle thread clamp device, as well as at the end of sewing by means of the thread trimmer which is provided with a shorter-thread remaining function. This means that manual thread nipping both at the beginning and at the end of sewing is no longer required, thereby helping reduce operator fatigue. Thanks to the adoption of a 2.7 fold-capacity hook, the frequency of bobbin thread changing is reduced and workability is improved.



LU-2828A-7

Model name	LU-2828A-7
Max. sewing speed	3,000sti/min
Gauge	A: Gauge for europe
Max. stitch length	9mm
Presser foot	By hand: 10mm, Auto: 20mm
Alternating vertical movement	1~9mm
Needle	134x35 (Nm140) Nm125~Nm180
Thread	#30~#5, B46~B138, Nm=60/3~20/3

Semi-dry Direct-drive, High-speed, 1-needle, Unison-feed, Lockstitch Machine with Vertical-axis Large Hook with automatic thread trimmer (long-pitch type)

LU-2810ESAL-7 (Long-pitch type (2.0 fold-capacity hook))

LU-2818ESAL-7 (Long-pitch type (2.7 fold-capacity hook))

LU-2828ESA-7 (2.7 fold-capacity hook, shorter-thread remaining type)

Increased maximum sewing speed of 3,800 sti/min* (LU-2810ESAL-7, 2.0 fold-capacity hook) and 3,500 sti/min* (LU-2818ESAL-7 and LU-2828ESA-7, 2.7-fold-capacity hook) is achieved. These models of sewing machines demonstrate increased productivity particularly when sewing long materials.

* The maximum sewing speed varies depending on sewing conditions.



LU-2810ESAL-7

Model name	LU-2810ESAL-7	LU-2818ESAL-7	LU-2828ESA-7
Max. sewing speed	3,800sti/min	3,500sti/min	
Max. stitch length	12mm	9mm	
Presser foot	Auto: 20mm, By hand: 10mm		
Alternating vertical movement	1~9mm		
Needle	135x17 (Nm160) Nm125~Nm200		
Thread	#30~#0, Nm=60/3~9/3		

Semi-dry Direct-drive, 1-needle, Unison-feed, Lockstitch Machine with Vertical-axis 2.7 fold-capacity Hook

LU-2810A-7/X73178

The machine is suited to sew car seats, sofas and bags, provided with dramatically improved workability and functions required for sewing large products and extra heavy-weight materials.



LU-2810A-7/X73178

Model name	LU-2810A-7/X73178
Max. sewing speed	3,000sti/min
Max. stitch length	9mm
Presser foot	By hand: 10mm, Auto: 20mm
Alternating vertical movement	1~9mm
Needle	135x17 (Nm160) Nm125~Nm180
Thread	#30~#5, B46~B138, Nm=60/3~20/3

Flat-bed Sewing Machine

High-speed, 1-needle, Unison-feed, Lockstitch Machine with Vertical-axis Large Hook and Automatic Thread Trimmer

- LU-2210N-7** (1.6 fold-capacity hook)
- LU-2210W-7** (Double-capacity hook)
- LU-2212N-7** (1.6 fold-capacity hook / 2-pitch dial type)
- LU-2220N-7** (1.6 fold-capacity hook / 2-pitch dial / Shorter thread remaining type)

The machine demonstrates outstanding performance when sewing heavy materials, with its "high-quality consistent sewing capabilities", as well as with its remarkably powerful feed. LU2220N-7 reduces thread nipping work required at the beginning and end of sewing. This is a high-performance machine which contributes to both increased productivity and improved quality for sewing car seats. Frequency of the use of scissors by the operator is reduced, thereby helping prevent the material from being damaged.

Model name	LU-2210N-7, LU-2210W-7	LU-2212N-7	LU-2220N-7
Max. sewing speed	3,500sti/min		
Max. stitch length	9mm (forward/backward)		
Max. lift of the presser foot	Auto: 16mm, By hand: 9mm		
Alternating vertical movement	1mm~6.5mm (by dial)		
Hook	N: Vertical-axis 1.6 fold-capacity hook W: Vertical-axis double-capacity hook	N: Vertical-axis 1.6 fold-capacity hook	
Needle	134x35R (Nm140) Nm110~Nm160		
Thread	#30~#4, B46~B138, Nm60/3~20/3		



LU-2220N-7

High-speed, 2-needle, Unison-feed, Lockstitch Machine with Vertical-axis Large Hooks

- LU-2260N-7** (1.6 fold-capacity hook)
- LU-2260W-7** (double-capacity hook)

The vertical strokes of the presser foot and walking foot (their alternating vertical movement) can be easily changed using a large dial mounted on the top surface of the machine head. In addition, the sewing speed is automatically adjusted with the set value. With this feature, ideal sewing conditions are maintained at all times.

Model name	LU-2260N-7, 2260W-7
Max. sewing speed	3,500sti/min
Max. stitch length	6mm
Presser foot	Auto: 16mm
Alternating vertical movement	1~6.5mm
Needle	134x35R (Nm140) Nm110~Nm160
Thread	#20~#5, B69~B138, Nm=40/3~20/3



LU-2260N-7

1-needle, Lockstitch, Zigzag Stitching Machine with Large Hook

- LZH-1290-7**
- LZH-1290**

The machine tenses thread uniformly over the zigzag stroke to produce beautifully finished stitches at a high speed. With its extended zigzag with higher presser foot lift, and newly introduced horizontal-axis double-capacity hook, the machine upgrades the functions required for the sewing of heavy materials.

Model name	LZH-1290-7	LZH-1290
Max. sewing speed	2,000sti/min	
Max. stitch length	6mm	
Presser foot	By knee: 11mm	By knee: 14mm
Zigzag width	Max. 8mm (adjustable to 10mm)	
Needle	SY1906 (Nm100) Nm90~Nm110	



LZH-1290-7

Cylinder-bed Sewing Machine

Cylinder-bed, 1-needle, Top and Bottom-feed, Lockstitch Machine

- DSU-142-7**
- DSU-145-7** (automatically lubricated for hook)
- DSU-142U**
- DSU-145U** (automatically lubricated for hook)

JUKI's DSU series sewing machines smoothly sew tubular materials such as bags and shoes, demonstrating outstanding capabilities when sewing small-diameter sections.

Model name	DSU-142U, 142-7	DSU-145U, 145-7
Max. sewing speed	2,000sti/min	
Max. stitch length	5mm	6mm
Presser foot	By knee: 13mm (with automatic thread trimmer) By knee: 15mm (without automatic thread trimmer)	
Alternating vertical movement	2~5mm	
Needle	DPx17, DPx5 (#18) #14~#18	DPx17 (#21) #14~#22
Thread	#50~#20	#50~#8



DSU-145-7

Cylinder-bed, 1-needle, Unison-feed, Lockstitch Machine

- DSC-244U**
- DSC-245U** (automatically lubricated for hook)
- DSC-246U** (double-capacity hook)
- DSC-245-7** (automatically lubricated for hook)
- DSC-246-7** (double-capacity hook)

The unison-feed provides the optimal feed efficiency by feeding heavy materials smoothly and firmly. The diameter of the cylinder is as small as $\phi 46\text{mm}$ for a standard hook or $\phi 50\text{mm}$ for a double-capacity hook. The small-diameter cylinder is quite helpful for handling bags, shoes, and other small articles smoothly and easily.

Model name	DSC-244U(V)	DSC-245U(V), 245(V)-7	DSC-246U(V), 246(V)-7
Application	V type: attaching of piping tape		
Max. sewing speed	2,200sti/min		
Max. stitch length	6mm		
Presser foot	By knee: 13mm, 15mm (without trimmer)	By knee: 14mm By knee: 15mm (without trimmer)	
Alternating vertical movement	3.0~4.8mm		
Needle	DPx17(#18) #14~#21	DPx17(#21) #14~#23	
Thread	#50~#20, B33~B69, Nm=120/3~40/3	#50~#8, B33~B92, Nm=120/3~30/3	



DSC-245-7

Cylinder-bed, 1-needle, Unison-feed, Lockstitch Machine

- DSC-245-7-0B/X55167** (standard hook)
- DSC-245U/X55200** (standard hook)
- DSC-245U/X55278** (standard hook and binder)

The machine provides good tightness of seams even with lower thread tension, and reduces the variances of stitch length at high and low speed. Thanks to a slide take-up lever, the responsiveness to thick threads has been further improved, and the ratio of alternating vertical movement remains unchanged even with the changes of material thickness.

Model name	DSC-245-7-0B/X55167	DSC-245/X55200	DSC-245/X55278
Max. sewing speed	2,200sti/min		
Max. stitch length	6mm (normal/reverse feed)		
Lift of the presser foot	By hand: 9mm, By knee: 16mm (max.)		
Alternating vertical movement	2.5~6.5mm		
Needle	135x17 (Nm130) Nm100~Nm180		
Thread	#50~#8, B33~B92, Nm=120/3~30/3		



DSC-245/X55200

Cylinder-bed Sewing Machine

Semi-long arm, cylinder-bed, 1-needle, unison-feed, lockstitch machine with a vertical-axis large hook

LS-2342-7 LS-2342

For this sewing machine, the distance from machine arm to needle has been increased to respond to the sewing of bags and furniture.

The machine inherits excellent operability of the predecessor model, and is provided with substantially improved workability and capabilities that are required for sewing large materials and extra heavy-weight materials.

Model name	LS-2342S-7	LS-2342S	LS-2342H-7	LS-2342H
Application	Standard		Thick-thread type	
Max. sewing speed	2,500sti/min		2,000sti/min	
Max. stitch length	9mm (nomal/reverse feed)			
Presser foot	By hand: 10mm, Auto: 20mm			
Alternating vertical movement	1~9mm			
Needle	134x35 (Nm140) Nm100~180		134x35 (Nm180) Nm100~180	
Thread	#30~#5	#40~#5	#20~#0	



LS-2342

Cylinder-bed, 1-needle, Unison-feed, Lockstitch Machine with Vertical-axis Hook

LS-1342-7 (gauge for small articles) LS-1342 (gauge for small articles)

LS-1341 LS-1340

The slimmed-down throat plate easily adjusts to the sewing of small tubular articles with diameters as small as $\phi 40$ mm. This enhances the machine's ability to smoothly sew not only bags and shoes, but also small article such as wallets. The newly developed mode of highly rigid rectangular feed guarantees outstanding feed performance.

Model name	LS-1342-7, 1342	LS-1341, 1340
Max. sewing speed	2,500sti/min	2,000sti/min
Max. stitch length	6mm	
Presser foot	By knee: 16mm	
Alternating vertical movement	1~6.5mm	2.5~6.5mm
Needle	135x17 (Nm160) Nm100~Nm180 (1342-7, 1342, 1341) 135x17 (Nm140) Nm100~Nm180 (1340)	
Thread	#30~#5, B46~B138, Nm=60/3~20/3 (1342-7) #40~#5, B33~B138, Nm=90/3~20/3 (1342, 1341) #50~#8, B33~B92, Nm=120/3~30/3 (1340)	



LS-1342-7

Cylinder-bed, 1-needle, Unison-feed, Lockstitch Machine with Vertical-axis Hook

LS-1341/X55287 (with dial for adjustment of alternating vertical movement)

The vertical stroke of the presser foot and walking foot (amount of alternating vertical movement) can be easily changed with the large dial mounted on the top of the machine head. This ensures ideal sewing conditions at all times.

Model name	LS-1341/X55287
Application	Heavy-weight
Max. sewing speed	2,000sti/min
Max. stitch length	6mm
Needle bar stroke	36mm
Needle	135x17 (Nm160) Nm125~Nm180
Thread	#30~#5, B46~B138, Nm=60/3~20/3

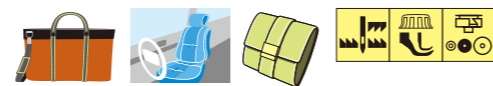

LS-1341/X55287

Cylinder-bed Sewing Machine

Cylinder-bed, 1-needle, Unison-feed, Lockstitch Machine with Vertical-axis Hook

LS-1342-7-0BB/X55275 (thick-thread type) LS-1342/X55274 (thick-thread type) LS-1342/X55280 (small-cylinder type)

LS-1342/X55280 is a machine with large vertical-axis hook which makes the throat plate on the tip of cylinder smallest to the utmost limit. Gauges for small articles are equipped as standard, therefore the machine is good at handling small articles and ideal for sewing articles with narrow gusset such as wallets and small bags.

LS-1342/X55274 and LS-1342-7-0BB/X55275 are machines which have more powerful feed and better responsiveness to thick thread the standard machines. The machine with automatic thread trimmer is provided as standard with an instantaneous change-over device for for the alternate vertical movement amount (DL device) and auto-lifter (AK device).

Model name	LS-1342-7-0BB/X55275	LS-1342/X55274	LS-1342/X55280
Max. sewing speed	2,000sti/min		
Max. stitch length	6mm (nomal/reverse feed)		4mm (nomal/reverse feed)
Hook	Vertical-axis 1.6 fold-capacity hook		
Needle thread tension control	Double tention type		
Needle	135x17 (Nm160) Nm100~Nm180		135x17 (Nm110) Nm100~Nm160
Thread	#30~#5, B46~B138, Nm=60/3~20/3	#20~#0, B69~B207, Nm=40/3~15/3	#40~#20, B33~B69, Nm=90/3



LS-1342/X55280



Post-bed Sewing Machine

Semi-dry Direct-drive, Post-bed, Unison-feed, Lockstitch Sewing System with Vertical-axis Hook

PLC-2710V-7 (1-needle, Large Hook)

PLC-2760V-7 (2-needle, Large Hook)

PLC-2710NVM-7 (1-needle)

PLC-2760NVM-7 (2-needle)

This new model digitalizes adjustment values required for sewing and easily transfers them to the main body of sewing machine by means of the ICT. Five adjustment values (stitch length, presser foot height, pressure foot pressure, alternate vertical movement amount of the walking foot and needle thread tension) required for sewing are digitalized. It is the most-advanced sewing machine which is best-suited to the sewing of heavy weight materials sewing processes such as car-seats, sofas and sports goods. The long distance from the machine arm to the needle contributes to improved workability.

Management, browsing and editing of data can be carried out on the application software

A "Two-way" contactless communication for parameter adjustment data can be conducted with the sewing machine by a commercial Android terminal. This feature allows sewing machines in a sewing line to be uniformly set and status checked quickly, thereby contributing to stabilization in product quality. Control panel is standardized with USB ports, promising simplicity in data management and system updates.



*Android OS Version 6.0 is recommended to use JUKI Smart APP. (Operation is confirmed with respect to Versions 5.0 and later.) Contact JUKI distributor in your area for how to use the application software.

The sewing machine can be paired with equipment which supports NFC (Near Field Communication) only by holding the equipment over the sewing machine.



PLC-2760V-7

Model name	PLC-2710V-7	PLC-2760V-7	PLC-2710NVM-7	PLC-2760NVM-7
Max. sewing speed	2,500sti/min			
Max. stitch length	9mm at the time of shipment (max. 12mm)			
Hook	Vertical-axis 2.0-fold capacity hook (latch type)		Vertical-axis hook (latch type)	
Presser foot	20mm			
Alternating vertical movement	0.5~9.0mm			
Needle	134x35 (Nm100~180, Standard Nm140)			
Thread	#30~#5			

Post-bed, 1-needle, Unison-feed, Lockstitch Machine

PLC-2710-7 (Large Hook)

PLC-2710 (Large Hook)

PLC-2710NM-7

It is sewing machine which is best-suited to the sewing of heavy weight materials sewing processes such as car-seats, sofas and sports goods. The long distance from the machine arm to the needle contributes to improved workability.

Model name	PLC-2710-7	PLC-2710	PLC-2710NM-7
Max. sewing speed	2,500sti/min		
Max. stitch length	12mm		
Hook	Vertical-axis 2.0-fold capacity hook (latch type)		Vertical-axis hook (latch type)
Presser foot	By hand:10mm, Auto: 20mm	By knee: 20mm	By hand:10mm, Auto: 20mm
Alternating vertical movement	1~9mm		
Needle	135x17 (Nm140) Nm100~Nm180		
Thread	#30~#5		



PLC-2710-7

Post-bed Sewing Machine

Post-bed, 2-needle, Unison-feed, Lockstitch Machine

PLC-2760-7 (Large Hook)

PLC-2760 (Large Hook)

PLC-2760L (thick-thread long-pitch type, Large Hook)

PLC-2765 (with organized split needlebars, Large Hook)

PLC-2760NM-7

It is sewing machine which is best-suited to the sewing of heavy weight materials sewing processes such as car-seats, sofas and sports goods. The long distance from the machine arm to the needle contributes to improved workability.



PLC-2760-7

Model name	PLC-2760-7	PLC-2760	PLC-2760L	PLC-2765	PLC-2760NM-7
Max. sewing speed	2,500sti/min		2,000sti/min	2,500sti/min	
Max. stitch length	12mm				
Hook	Vertical-axis 2.0-fold capacity hook (latch type)				Vertical-axis hook (latch type)
Presser foot	Auto: 20mm, By hand: 10mm	By knee: 20mm	Auto: 20mm, By hand: 10mm	Auto: 18mm, By hand: 10mm	Auto: 20mm, By hand: 10mm
Alternating vertical movement	1~9mm				
Needle	135x17 (Nm140) Nm100~Nm180		135x17 (Nm200) Nm140~Nm200	135x17 (Nm140) Nm100~Nm180	
Thread	#30~#5, B46~B138, Nm=60/3~18/3		#8~#0, B92~B207, Nm=30/3~15/3	#30~#5, B46~B138, Nm=60/3~18/3	

Post-bed, 1-needle, Unison-feed, Lockstitch Machine

PLC-1710-7

PLC-1710

This machine with a thread trimmer utilizes a basic performance which matches best to the sewing of heavy materials such as car seats and furniture. The vertical strokes of the presser foot and walking foot (amount of alternating vertical movement of the walking foot and presser foot) can be easily changed using the large dial mounted on the top of the machine head.

Model name	PLC-1710-7, 1710
Max. sewing speed	2,500sti/min
Max. stitch length	9mm
Presser foot	Auto: 16mm
Alternating vertical movement	1~6.5mm (1710-7, 1760-7, 1760L) 2.5~6.5mm (1710, 1760)
Needle	134x35 (Nm140) Nm110~Nm160
Thread	#30~#5, B46~B138, Nm=60/3~20/3



PLC-1710-7

Post-bed Sewing Machine

Post-bed, 2-needle, Unison-feed, Lockstitch Machine

PLC-1760-7 

PLC-1760

PLC-1760L (thick-thread long-pitch type) 

This machine with a thread trimmer utilizes a basic performance which matches best to the sewing of heavy materials such as car seats and furniture. The vertical strokes of the presser foot and walking foot (amount of alternating vertical movement of the walking foot and presser foot) can be easily changed using the large dial mounted on the top of the machine head.



PLC-1760-7

Model name	PLC-1760-7, 1760	PLC-1760L
Max. sewing speed	2,500sti/min	1,800sti/min (p=0~10mm) 1,600sti/min (p=10~12mm)
Max. stitch length	9mm	12mm
Presser foot	Auto: 16mm	
Alternating vertical movement	1~6.5mm (1710-7, 1760-7, 1760L) 2.5~6.5mm (1710, 1760)	
Needle	134x35 (Nm140) Nm110~Nm160	134x35 (Nm200) Nm140~Nm200
Thread	#30~#5, B46~B138, Nm=60/3~20/3	#8~#0, B92~B207, Nm=30/3~15/3

High-post-bed, 1-needle, Unison-feed, Lockstitch Machine with Vertical-axis Hook

PLC-1690 (1.6 fold-capacity hook) 

PLC-1691 (standard hook)

The high post-bed machine is best-suited to the 3-dimensional sewing of bags, etc. The newly developed high post-bed machine has a post with a compact-finished top to support difficult sewing processes that conventional machine can't handle such as bottom sewing or gore sewing.



PLC-1690

Model name	PLC-1690	PLC-1691
Max. sewing speed	1,600sti/min	
Max. stitch length	6mm	
Presser foot	By knee: 15mm	By knee: 10.5mm
Post height	420mm	425mm
Alternating vertical movement	2~7mm	
Needle	134x35R (Nm120) Nm100~Nm140	
Thread	#30~#8, B46~B92, Nm=60/3~30/3	

Post-bed, Bottom-feed, Lockstitch Machine

PLH-981U (1-needle) 

PLH-982U (2-needle) 

Post-bed, Needle-feed, Lockstitch Machine

PLN-985U (1-needle) 

With a needle feed mechanism that operates in synchronization with the bottom feed, the machine produces beautiful seams free from slippage even when sewing slippery or hard-to-feed materials.



PLN-985U

Model name	PLH-981U, 982U	PLN-985U
Max. sewing speed	2,500sti/min	
Max. stitch length	4mm	
Presser foot	By knee: 10mm	By knee: 9mm
Needle	DPx5 (#18) #16~#21	DPx5 (#16) #16~#21
Thread	#40~#8, B33~B92, Nm=90/3~30/3	

Long Arm Sewing Machine

Long-arm, Unison-feed, Lockstitch Machine with Vertical-axis Large Hook

LU-2216N-7 (1-needle)

LU-2266N-7 (2-needle) 

Based on the market-proven design of the LU-2210N-7 and -2260N-7 Series, the LU-2216N-7 / -2266N-7 are developed with a longer distance from the machine arm to needle ... a full 650mm. The long arm unison-feed lockstitch machine with vertical-axis large hook with automatic thread trimmer is best-suited to processes that require a longer distance from the machine arm to needle, such as reinforcement stitching and topstitching in tape attachment processes for sewing furniture or car seats.

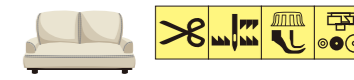

LU-2266-7

Model name	LU-2216N-7	LU-2266N-7
Max. sewing speed	3,000sti/min	
Max. stitch length	9mm	6mm
Presser foot	Auto: 16mm	
Alternating vertical movement	1~6.5mm	
Distance from needle to machine arm	650mm	
Needle	134x35R (Nm140) Nm110~Nm160	
Thread	#30~#4, B46~B138, Nm=40/3~20/3	#20~#5, B69~B138, Nm=40/3~20/3

Long-arm, Unison-feed, Lockstitch Machine with Vertical-axis Large Hook

LG-158-1U (1-needle)

LG-158U (2-needle) 

With a generous 750mm of free space under the arm and powerful unison-feed that provides a maximum stitch length of 10mm, the machine delivers outstanding productivity when sewing heavy materials such as tents and sheets.

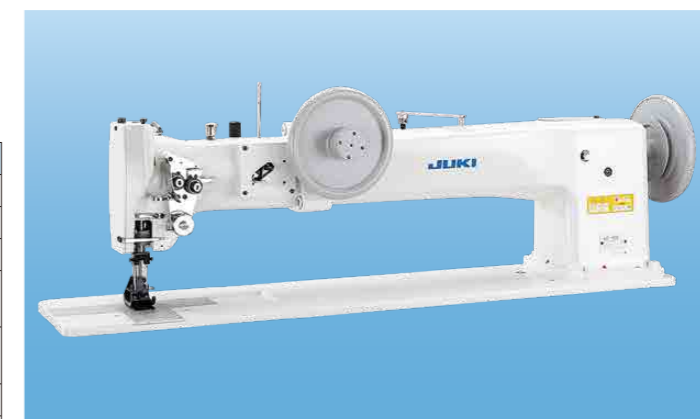
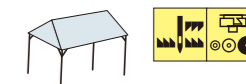

LG-158U

Model name	LG-158-1U, 158U
Max. sewing speed	1,500sti/min
Max. stitch length	10mm
Presser foot	By pedal: 21.5mm
Alternating vertical movement	6~19mm
Distance from needle to machine arm	750mm
Needle	DDx1 (#25)
Thread	#20~#5, B69~B138, Nm=40/3~20/3

Super-long Cylinder-bed, 1-needle, Lockstitch Machine with Large Shuttle-hook for Extra Heavy-weight Materials

TSC-461U

It is equipped with a free space under the arm as wide as 950mm, which means that the machine is capable of sewing large materials, long-sized materials and tubular sewn products with ease.

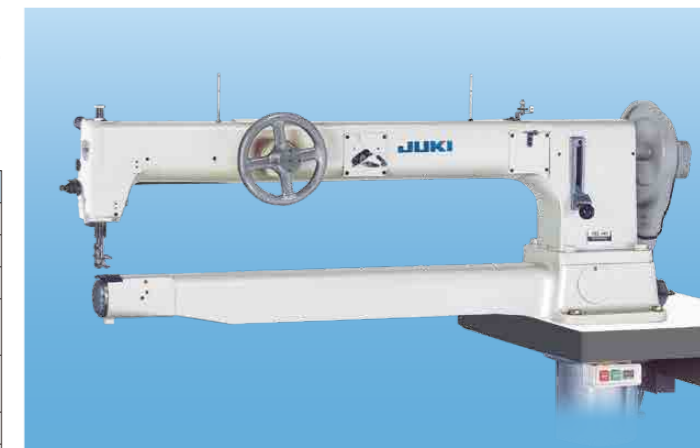



TSC-461U

Model name	TSC-461U
Max. sewing speed	650sti/min
Max. stitch length	11mm
Presser foot	By pedal: 20mm
Alternating vertical movement	4~8mm
Distance from needle to machine arm	950mm
Needle	794 (Nm230) Nm130~Nm280
Thread	#8~#0, B92~B207, Nm=30/3~15/3

Flat-bed Sewing Machine for Extra Heavy-weight Materials

Semi-long Flat-bed, 1-needle, Lockstitch Machine with Large Shuttle-hook for Extra Heavy-weight Materials

TNU-243U (unison-feed) 
TU-273U (top and bottom-feed) 

The machine is optimally suited for the sewing of extra heavy-weight materials such as tents, seat belts, and bag handles.





Model name	TNU-243U, TU-273U
Max. sewing speed	800sti/min
Max. stitch length	15mm
Presser foot	By knee: 20mm
Alternating vertical movement	4~8mm
Distance from needle to machine arm	420mm
Needle	794 (Nm230) Nm130~Nm280 DYx3 #21~#28
Thread	#8~#0, B92~B207, Nm=30/3~15/3



TNU-243U

Cylinder-bed Sewing Machine for Extra Heavy-weight Materials

Semi-long Cylinder-bed, 1-needle, Lockstitch Machine with Large Shuttle-hook for Extra Heavy-weight Materials

TSH-411U (bottom-feed) 
TSN-421U (needle-feed) 
TSC-441U (unison-feed) 
TSU-471U (top and bottom-feed) 

The lifting range of the presser foot is as high as 20mm for smooth placement / removal of extra heavy-weight materials. The machine has a wider free space under the machine arm to allow the operator to easily place and remove a large sewing products.

Model name	TSH-411U, TSN-421U TSC-441U, TSU-471U
Max. sewing speed	800sti/min
Max. stitch length	11mm
Presser foot	By pedal: 20mm
Alternating vertical movement	4~8mm (TSC-441, TSU-471)
Distance from needle to machine arm	420mm
Needle	794 (Nm230) Nm130~Nm280
Thread	#8~#0, B92~B207, Nm=30/3~15/3



TSC-441U

Bartacking Machine

Computer-controlled, High-speed Bartacking Sewing System

LK-1900BN-HS (for heavy-weight)
LK-1900BN-WS (for extra heavy-weight) 

The machine achieves a maximum sewing speed of 3,200sti/min (Normal hook type), enhancing the startup speed at the beginning and ending of sewing, as well as the speed of thread trimming, thus reducing the total cycle time. It therefore achieves upgraded productivity.

Management, browsing and editing of data can be carried out on the application software

A "Two-way" contactless communication for parameter adjustment data can be conducted with the sewing machine by a commercial Android terminal. This feature allows sewing machines in a sewing line to be uniformly set and status checked quickly, thereby contributing to stabilization in product quality. Control panel is standardized with USB ports, promising simplicity in data management and system updates.



*Android OS Version 6.0 is recommended to use JUKI Smart APP. (Operation is confirmed with respect to Versions 5.0 and later.) Contact JUKI distributor in your area for how to use the application software.

 The sewing machine can be paired with equipment which supports NFC (Near Field Communication) only by holding the equipment over the sewing machine.



LK-1900BN-HS

Model name	LK-1900BN-HS	LK-1900BN-WS
Sewing area	30mm (L)×40mm (W)	
Max. sewing speed	3,200sti/min	2,700sti/min
Stitch length	0.1mm~10mm (0.1mm step)	
Work clamp foot	14mm (17mm when the reverse-rotation needle-up function)	
Needle	DPx17 (#21)	
Number of standard patterns	51 patterns	
Number of data that can be input	200 patterns	

Shape-tacking Machine

Computer-controlled, High-speed Shape-tacking Machine

LK-1910
LK-1920 (with intermediate presser)

The sewing speed of 2,500 sti/min is the fastest-level sewing speed among the shape-tacking machines. The sewing machine has adopted a semi-rotary two-fold capacity hook. In addition, the sewing machine comes with enhanced functions such as the feeding frame with a higher lift and the direct-drive machine head that provides excellent responsiveness and stop accuracy support the machine's high-speed performance, thereby achieving increased productivity.

Model name	LK-1910S, 20S	LK-1910H, 20H
Application	Standard	Heavy-weight
Sewing area	60mm (L)×100mm (W)	
Max. sewing speed	2,500sti/min	
Stitch length	LK-1910,20 : 0.1~10mm	
Number of data that can be input	LK-1910,20 : 64 patterns	
Needle	DPx5 (#14), DPx17 (#18)	



LK-1920

Computer-controlled Cycle Machine

CNC Sewing machine (head turning type)

AMS-251 (1-needle • X: 1000mm × Y: 600mm)

AMS-252/X77026

(2-needle • X: 1000mm × Y: 600mm) 

Option: Camera System [No.4021067]

JUKI's unique synchronization technology controls the machine head, hook and feed mechanism, thereby creating the most favorable seams. In case of continuous circumference sewing, the sewing machine constantly detects the direction of sewing. As a result, consistent-quality seams are produced regardless of the direction of sewing.

The sewing machine is ideally suited to the sewing of decorative stitches on car seats, luxury bags and school bags, but also to the sewing of large-sized products with zero design tolerance for irregular stitches. In addition, the sewing machine can be used for sewing two or more pieces of small products at a time.

This device (4021067) contributes to expanded design possibility of decorative stitches for car seats, etc. Thanks to JUKI's original image recognition technology, this sewing machine enables sewing of hard-to-sew perforated materials as desired and produces beautifully-finished seams.



AMS-251/Camera System (40210671)

Model name	AMS-251	AMS-252/X77026
Type	1-needle	2-needle
Application	Medium - Heavy	
Needle (at the time of delivery)	DP×17, #18 - 25 (#23)	
Thread	Nm 60/3 - 20/3	
Hook	Rotary Hook, Horizontal - Axis, 3 fold - capacity	Vertical - Axis, 2.7 fold - capacity

Option: Camera System [No.4021067]



Touch panel monitor, PC Cameras

Computer-controlled Cycle Machine with Input Function (Full-rotary hook type) (Automatic bobbin-thread winding and feeding device)

AMS-224EN-4530R/AW-3

(X: 450mm × Y: 300mm)

AMS-224EN-6030R/AW-3

(X: 600mm × Y: 300mm)

The AMS-224EN4530RS has adopted the full-rotary type hook. The automatic bobbin-thread winding and feeding device (AW-3) which is suited to the sewing of large articles such as car seats is optionally available. In the case of sewing large articles, etc, a large quantity of bobbin thread is consumed during sewing of one article. This means that replacement of bobbin frequently occurs. Since the AW-3 changes the bobbin automatically after sewing, the operator is able to concentrate on sewing without worrying about shortage of bobbin thread. In addition, only two bobbin cases are required for sewing.

As a result, burdensome control of bobbin thread tension and bobbin-changing work are no longer required, thereby contributing to increased productivity.



AMS-224EN-4530R/AW-3

Model name	AMS-224EN-4530R/AW-3	AMS-224EN-6030R/AW-3
Application	Medium-to heavy-weight	Extra heavy-weight
Max. sewing speed	2,500sti/min (stitch length 3mm or less)	
Sewing area	X: 450mm - Y: 300mm	X: 600mm - Y: 300mm
Settable stitch length	0.1~12.7mm (0.05mm step)	
Needle	DP×17 (#18)	DP×17 (#23)
Compressed air / Air consumption	0.5~0.55MPa (Max. 0.55MPa) / 156dm ³ /min (with AW-3)	

Computer-controlled Cycle Machine

Computer-controlled Cycle Machine with Input Function (Full-rotary hook type)

AMS-224EN-4530R

(X: 450mm × Y: 300mm)

The machine not only achieves higher productivity due to instantaneous increases/decreases in sewing speed at the beginning/end of sewing and increased speed of thread trimming, but also achieves a flexible responsiveness to materials to promise enhanced seam quality due to JUKI's unique active tension and programmable intermediate presser.



AMS-224EN-4530R

Model name	AMS-224EN-4530R
Application	Medium-to heavy-weight
Max. sewing speed	2,500sti/min (stitch length 3mm or less)
Sewing area	X: 450mm - Y: 300mm
Settable stitch length	0.1~12.7mm (0.05mm step)
Needle	DP×17 (#18)
Compressed air / Air consumption	0.5~0.55MPa (Max. 0.55MPa) / 1.8dm ³ /min (without AW-3)

Computer-controlled Cycle Machine with Input Function (Rotary hook type)

AMS-221F-3020R/AW-3

(with Automatic bobbin-thread winding and feeding device)

AMS-221F-3020R

The AMS-221F-3020R has adopted the rotary type hook. This machine has high sewing machine operation rate and bobbin thread occurs frequently replacement. Since the AMS-221F-3020R/AW-3 changes the bobbin automatically before the bobbin-thread runs out and bobbin-thread is wound during sewing, the operator is able to concentrate on sewing with out worrying about shortage of bobbin thread. In addition, only two bobbin cases are required for sewing. As a result, burdensome control of productivity, bobbin thread tension and bobbin-changing work are no longer required, thereby contributing to increased productivity.

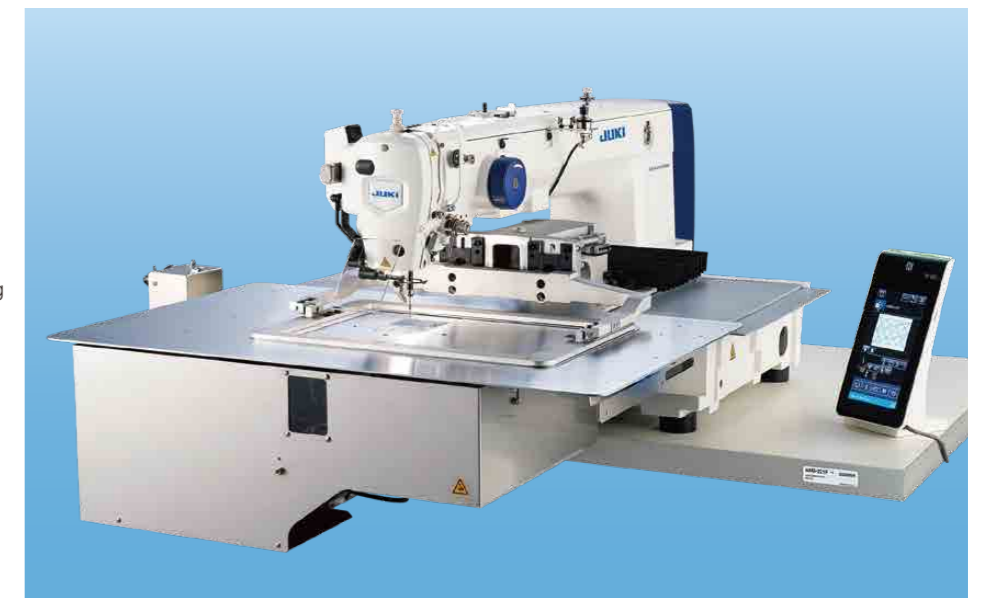

AMS-221F-3020R/AW-3

Model name	AMS-221F-H3020R/AW-3 AMS-221F-H3020R	AMS-221F-G3020R/AW-3 AMS-221F-G3020R
Application	Medium- to heavy-weight	Extra heavy-weight
Max. sewing speed	2,800sti/min*	
Sewing area	300mm (X) × 200mm (Y)	
Settable stitch length	0.1~12.7mm (0.05mm step)	
Needle	DP×17 (#18)	DP×17 (#23)
Compressed air / Air consumption	0.35~0.55MPa (Max. 0.55MPa) / 156dm ³ /min (with AW-3), 1.8dm ³ /min	

Computer-controlled Cycle Machine with Input Function

AMS-221F-2516
(X: 250mm x Y: 160mm)
AMS-221F-3020
(X: 300mm x Y: 200mm)



AMS-221F has achieved increased productivity with its maximum sewing speed of 2,800 sti/min and beautifully finished seams with its new feed control system. The active tension can be changed over with the memory switch between the low-tension side output and the high-tension side output to enable fine adjustment of the thread tension in the actual area of use.



AMS-221F-2516

Management, browsing and editing of data can be carried out on the application software

A "Two-way" contactless communication for parameter adjustment data can be conducted with the sewing machine by a commercial Android terminal. This feature allows sewing machines in a sewing line to be uniformly set and status checked quickly, thereby contributing to stabilization in product quality. Control panel is standardized with USB ports, promising simplicity in data management and system updates.

*Android OS Version 6.0 is recommended to use JUKI Smart APP. (Operation is confirmed with respect to Versions 5.0 and later.) Contact JUKI distributor in your area for how to use the application software.

The sewing machine can be paired with equipment which supports NFC. (Near Field Communication) only by holding the equipment over the sewing machine.



Model name	AMS-221F-S	AMS-221F-H	AMS-221F-G
Application	Light-to medium-weight	Medium-to heavy-weight	Heavy-to Extra heavy-weight
Max. sewing speed	2,800sti/min		
Sewing area	0.1~12.7mm (0.05mm step)		
Storage of pattern data in the memory	Main-body memory : Max. 50,000,000 stitches, 999 patterns (max. 50,000 stitches / pattern)		
	External media : Max. 50,000,000 stitches, 999 patterns (max. 50,000 stitches / pattern)		
Needle	DPx5 (#14)	DPx17 (#18)	DPx17 (#23)

Computer-controlled Cycle Machine with Input Function

AMS-210EN-1306 (X: 130mm x Y: 60mm)
AMS-210EN-1510 (X: 150mm x Y: 100mm)
AMS-210EN-2210 (X: 220mm x Y: 100mm)
AMS-221EN-2516 (X: 250mm x Y: 160mm)
AMS-221EN-3020 (X: 300mm x Y: 200mm)



The sewing machine achieves the highest sewing speed, 2,800sti/min, in the industrial sewing machine industry. As a result, cycle time is dramatically reduced. The feed accuracy is substantially improved due to the adoption of the encoder control system. The new AMS Series models substantially decrease power consumption when compared with the conventional ones. They have been designed to achieve eco-friendliness.

AMS-210EN-1306 (X: 130mm x Y: 60mm)

The sewing machine flexibly supports the sewing of small articles such as labels and emblems. The sewing machine's small sewing area promises ease of use when handling small articles, thereby enabling smooth sewing operation.

AMS-210EN-1510 (X: 150mm x Y: 100mm)

The 1510 model is well received in the market due to its moderate-sized sewing area. Responding to market demand, the 1510 area model with a motor-driven feeding frame has been newly developed. This model can be used in a plant which is not provided with pneumatic equipment.

AMS-210EN-2210 (X: 220mm x Y: 100mm)

This model has a sewing area that is best-suited to the sewing of large parts, including the shape-tacking of jean pockets. With this model, you may recognize the higher productivity of the cycle machine.

AMS-221EN-2516 (X: 250mm x Y: 160mm)

The sewing machine is best-suited to the sewing of large labels and emblems, the sewing of two or more pieces of small labels and emblems at one time, and the shape-tacking of bags and shoes. The sewing machine is applicable to a broad range of materials and processes, while leading the industrial sewing machine industry in terms of improvement in quality and the promotion of production that does not require sewing-machine operators to have special skills.

AMS-221EN-3020 (X: 300mm x Y: 200mm)

The sewing machine is applicable to sewing products which require a wider sewing area than that of the "AMS-221EN-2516." It is best-suited to the attaching of handles to bags and the shape-tacking of boots and shoes. The sewing machine is flexibly applicable to sewing requiring a medium sewing area.



AMS-210EN-1510

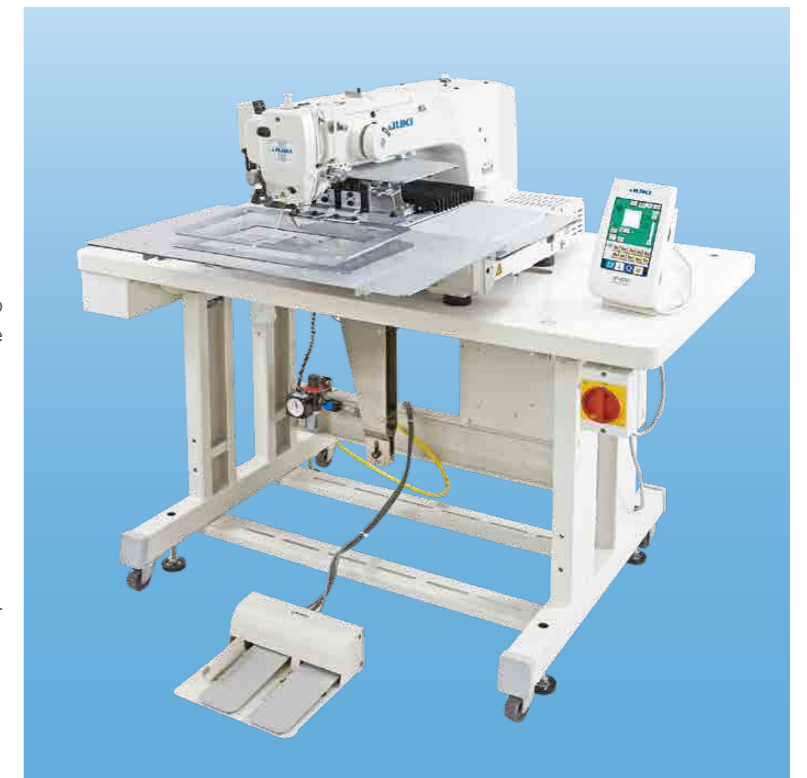

AMS-221EN-2516

Model name	AMS-210EN-SS	AMS-210EN-HS	AMS-221EN-SL	AMS-221EN-HL
Application	Light- to medium-weight	Medium- to heavy-weight	Light- to medium-weight	Medium- to heavy-weight
Max. sewing speed	2,800sti/min*			
Stitch length	0.1~12.7mm (0.05mm step)			
Storage of pattern data in the memory	Main-body memory: Max. 50,000 stitches, 999 patterns (max. 50,000 stitches / pattern)			
	External media: Max. 50,000,000 stitches, 999 patterns (max. 50,000 stitches / pattern)			
Needle	DPx5 (#14)	DPx17 (#18)	DPx5 (#14)	DPx17 (#18)

*Stitch length is 4mm or less for the AMS-210EN and 3.5mm or less for the AMS-221EN.

Computer-controlled Cycle Machine

Computer-controlled Cycle Machine with Input Function
(with a full-rotary, 3-fold capacity hook)

AMS-210EN-ZL1510RZC/X90022

(X: 150mm x Y: 100mm) *Needle plate auxiliary cover: with 2210 type

AMS-210EN-ZL1510RZC/X90023

(X: 150mm x Y: 100mm) <Provided with a wide-type auxiliary cover>

AMS-210EN-ZL1510RZC/X90030

(X: 150mm x Y: 100mm) <for CE>

This machine has been designed for thick threads and is particularly suited to the sewing of seatbelts, safety belts, and extra-heavy-weight materials. The 3-fold capacity & full-rotary hook contributes to the achievement of soft-texture beautifully-finished seams. JUKI's unique thread-trimming mechanism achieve increased productivity and improved sewing quality.

Model name	AMS-210EN-ZL1510RZC/X90022*1	AMS-210EN-ZL1510RZC/X90023	AMS-210EN-ZL1510RZC/X90030*2
Max. sewing speed	2,200sti/min (less than 4.5mm)		
Sewing area	X: 150mm x Y: 100mm		
Stitch length	0.1 to 12.7mm (in increments of 0.05mm)		
Hook	triple capacity full-rotary hook		
Needle	DPx17 (#25) #25~26		
Air consumption	4.7dm ³ (ANR) /min		
Power supply	Single-phase 200-240V	3-phase 200-240V	Single-phase 200-240V (for CE)

*1. Needle plate auxiliary cover: with 2210 type *2. for CE, eco type (simple operation panel, without accessories)



AMS-210EN-ZL1510RZC/X90023

Computer-controlled Cycle Machine with Input Function

AMS-224EN-4530 (X: 450mm x Y: 300mm)

AMS-224EN-6030 (X: 600mm x Y: 300mm)

AMS-224ENHC10050

(X: 1,000mm x Y: 500mm) Production by order

The machine achieves the highest sewing speed of 2,500sti/min among those with a similar sewing area. With its higher productivity, the machine performs various kinds of stitching, making the most out of its wider sewing area in various sewing applications such as attaching handles to bags and pouches, attaching belts, sewing many small parts at a time, attaching parts to shoes and sports shoes (one pair of shoes) and sewing air bags. A newly developed encoder-controlled stepping motor system has been adopted for the X-Y feed mechanism. This contributes to more accurate sewing performance and increased productivity.



AMS-224EN-6030

Model name	AMS-224EN-HS	AMS-224EN-GB
Application	Medium- to heavy-weight	Extra heavy-weight
Max. sewing speed	2,500sti/min (stitch length 3mm or less)	
Settable stitch length	0.1~12.7mm (0.05mm step)	
Storage of pattern data in the memory	Main-body memory: Max. 500,000 stitches, 999 patterns (max. 50,000 stitches / pattern)	
	External media: Max. 50,000,000 stitches, 999 patterns (max. 50,000 stitches / pattern)	
Needle	DPx17 (#18)	DPx17 (#23)

Computer-controlled Cycle Machine with Input Function
(for total-area perfect stitching)

AMS-224EN-4530/X7910 (X: 450mm x Y: 300mm)

AMS-224EN-6030/X7910 (X: 600mm x Y: 300mm)

AMS-224ENHC10050/X7970

(X: 1,000mm x Y: 500mm) Production by order

AMS-224EN/X7910 has removed the area where hitch stitches are produced to make the total area capable of sewing with perfect stitches, thereby improving the seam quality.

Model name	AMS-224EN-4530/X7910	AMS-224EN-6030/X7910
Max. sewing speed	1,500sti/min (stitch length 6mm or less)	
Stitch length	0.1~12.7mm (0.05mm step)	
Storage of pattern data in the memory	Main-body memory: Max. 500,000 stitches, 999 patterns (max. 50,000 stitches / pattern)	
	External media: Max. 50,000,000 stitches, 999 patterns (max. 50,000 stitches / pattern)	
Needle	DPx17 (#18)	



AMS-224EN-6030/X7910

Computer-controlled Cycle Machine

Computer-controlled Cycle Machine with Input Function
(for large products such as air bags)

AMS-224EN-6060 (X: 600mm x Y: 600mm)

The sewing area is broadened to "600 mm (width) x 600 mm (length)". This sewing machine is best-suited to the sewing of large products such as air bags.

Model name	AMS-224EN-6060
Max. sewing speed	2,000sti/min (stitch length 3mm or less)
Settable stitch length	0.1~12.7mm (0.05mm step)
Storage of pattern data in the memory	Main-body memory: Max. 500,000 stitches, 999 patterns (max. 50,000 stitches / pattern)
	External media: Max. 49,950,000 stitches, 999 patterns (max. 50,000 stitches / pattern)
Needle	DPx17 (#24) Bpoint (135x17 FG Nm180)



AMS-224EN-6060

Computer-controlled Cycle Machine (for slide-type thread take-up lever)

AMS-210EN-HL1306/7300

(X: 130mm x Y: 60mm)

The machine with a slide-type thread take-up lever is designed for improved stitching with heavy threads tension. JUKI's unique active tension mechanism which has been re-designed specifically for heavy-weight materials, as well as the slide-type thread take-up lever which is suited for sewing heavy-weight materials, increase the maximum tension by 50% more compared to that of the standard models of the JUKI AMS Series machines. The new model improves seam quality (thread tension) for sewing seat belts and general heavy-weight materials such as container belts and bags.

Model name	AMS-210EN-HL1306/7300
Application	Medium-to heavy-weight
Max. sewing speed	2,000sti/min (when stitch length is 4.5mm or less)
Thread take-up	Slide-type thread take-up lever (dry frame)
Needle	DPx17 #25 (max. #26)



AMS-210EN-HL1306/7300

Computer-controlled Cycle Machine with Tape Feeding Device

AMS-210EN-HL2210/TF10S

(for attaching decorative tapes)

The machine is ideal for attaching decorative tapes and reinforcing tapes required on sewing such as shoes and bags. Measure & cut each stripes specified length for quarter automatically. Stripe are feeded accurately for sewing position of a quarter. Operators don't need to cut stripe tape.

Model name	AMS-210EN-HL2210/TF10S
Normal sewing speed	2,000sti/min
Stitch length	0.1~12.7mm (0.05mm step)
Material of tape	Synthetic leather, coating & enamel etc..
Width of tape	10.0~16.7mm (0.1mm step)
Length of tape	55~130mm (1.0mm step)
Thickness of tape	~1.5mm
Needle	DPx17 (#16)



AMS-210EN-HL2210/TF10S

Computer-controlled Cycle Machine

Computer-controlled Cycle Machine with Input Function
(for 2-color-thread sewing)



AMS-221EN-TS3020 (X: 300mm x Y: 200mm)

This machine (AMS221EN-TS) for two-color stitching has been developed to enable two-color stitching (with two kinds of thread which are different in color). Possible difference in position of the sewing product which can be caused by re-placing it on the sewing machine in a different process is eliminated, thereby increasing the productivity. It is suitable for sports shoes, bags and car seats such as the topstitch and parts sewing, etc.



AMS-221EN-TS3020

Model name	AMS-221EN-TS3020
Max. sewing speed	2,500sti/min
Stitch length	0.1~12.7mm (0.05mm step)
Storage of pattern data in the memory	Main-body memory : Max. 500,000 stitches, 999 patterns (max. 50,000 stitches / pattern)
	External media : Max. 50,000,000 stitches, 999 patterns (max. 50,000 stitches / pattern)
Needle	DPx17 (#18)

Automatic Bobbin Thread Wind-and-Feed Device (Retrofit Kit for AMS-EN Series Shuttle Hook Machine)

AW-3S

This is Automatic Bobbin Thread Wind-and-Feed Device that can be retrofitted to the computer-controlled cycle machine with a semi-rotary hook, AMS-221EN and AMS-224EN. Improved seam quality, productivity and operability are achieved by installing this device to the sewing machine! This device is suitable for the sewing of products such as air bags, sports shoes and bags.



Example of installation of AW-3S retrofitted

AMS-221EN

Device	AW-3S
Sewing machine head to which the device is installed	AMS-221EN / AMS-224EN (sewing machine head with a semi-rotary hook)
Applicable bobbin and bobbin case	Exclusive bobbin and bobbin case
Thread	#5~#30, 135~45(TEX), 020~060(TKT)
Applicable types of thread	Tetoron thread, nylon thread
Remaining thread removal operation, bobbin winding and threading operations	Automatic (while the sewing machine is in operation)

Automatic Machine

Automatic 1-needle shoelace loop attaching machine (Provided with a preset loader)

AB-1360/CR-10A

The AB-1360 / CR-10A sewing machine with a preset loader automatically feeds shoelace loops and shoe tongues to the correct shoelace loop attaching position, thereby no longer requiring manual positioning of those parts. The sewing machine is an automatic machine which realizes full-automatic sewing while eliminating inconsistency in quality and sewing position faults caused by the operator.



AB-1360/CR-10A

Model name	AB-1360/CR-10A
Machine head	LK-1962/ABH (Specifically-designed semi-dry machine head)
Max. sewing speed	2,500sti/min
Lift of work clamp foot	20mm
Hook	Horizontal-axis rotary hook
Needle bar stroke	45.7mm
Needle	DPx17 (#18)
Shoelace loop width	6~12mm
Finished length of shoelace loop	15~20mm

Automatic Machine

Automatic 1-needle shoelace loop attaching machine

AB-1360

This model of sewing machine achieves increased productivity by automatizing shoelace loop sewing process for sports shoes. The machine carries out cutting, folding and sewing of shoelace loops in one process, thereby contributing to labor-saving and deskilling. The machine is provided as standard with an LED marking light (crisscross light), thereby facilitating positioning of shoelace loops at the correct sewing position. In addition, the machine comes with a heat-cutting mechanism to cut shoelace loops to constant dimensions with consistency without fail.



AB-1360

Model name	AB-1360
Machine head	LK-1962/ABH (Specifically-designed semi-dry machine head)
Max. sewing speed	2,500sti/min
Lift of work clamp foot	20mm
Hook	Horizontal-axis rotary hook
Needle bar stroke	45.7mm
Needle	DPx17 (#18)
Shoelace loop width	6~12mm
Finished length of shoelace loop	15~20mm

Pattern Seamer

PS-800-13085

(X: 1,300mm x Y: 850mm)

PS-800-12080

(X: 1,200mm x Y: 800mm)

PS-800-8045

(X: 800mm x Y: 450mm)

PS-800-6045

(X: 600mm x Y: 450mm)

The dry head machine achieves max. speed 3,000sti/min with supporting various sewing and materials. There are 4 types of sewing areas. The PS-800-8045 can be installed in a space-saving manner. The table size width is 1,200mm, the same as 1-needle lockstitch machine.



PS-800-12080

Model name	PS-800SB13085	PS-800HB13085	PS-800SB8045	PS-800HB8045	PS-800SB6045	PS-800SS12080	PS-800HS12080
Sewing area	1,300 mm x 850 mm		800 mm x 450 mm		600 mm x 450 mm	1,200 mm x 800 mm	
Feeding type	Double stepping motor Belt Drive					Screw drive (ball screw)	
Max. sewing speed	3,000 sti/min						
Stitch length	0.5 - 12.7 mm						
Needle	DB x 1 #8 (7#~14#)	DP x 17 #21 (18#~23#)	DB x 1 #8 (7#~14#)	DP x 17 #21 (18#~23#)	DB x 1 #8 (7#~14#)		DP x 17 #21 (18#~23#)
Dimensions	2,190mm (W) x 2,100mm (L) x 1,250mm (H)		1,200mm (W) x 1,325mm (L) x 1,250mm (H)		1,560mm (W) x 1,200mm (L) x 1,250mm (H)	2,180mm (W) x 2,185mm (L) x 1,250mm (H)	

Pattern Seamer

PS-800HB-8045ZKZ/X88009 (for Shoes, bag)

(X: 600mm x Y: 410mm)

This machine is a special model modified for shoes and bags. The dry head machine achieves max. speed 3,000sti/min with supporting various sewing and materials. The PS-800-8045 can be installed in a space-saving manner. The table size width is 1,200mm, the same as 1-needle lockstitch machine.



PS-800HB-8045ZKZ/X88009

Model name	PS-800HB-8045ZKZ/X88009
Sewing area	600 mm x 410 mm
Feeding type	Double stepping motor Belt Drive
Max. sewing speed	3,000 sti/min
Stitch length	0.5 - 12.7 mm
Needle	DP x 17 #21 (18#~23#)
Dimensions	1,200mm (W) x 1,325mm (L) x 1,250mm (H)

Overlock / Safety Stitch Machine for Extra Heavy-weight Materials

MO-6900G Series

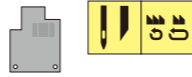

The machine incorporates a mechanism and parts that are optimum for the sewing of extra heavy-weight materials, such as an extra high-lift type upper looper, tractor foot and coarse type feed dog. It demonstrates an excellent performance ability in the sewing of various kinds of heavy-weight materials such as jeans, raised fabric materials, mats and carpets.



MO-6905G

Model name	MO-6905G-0M6-7E0
Application	For car mats
Stitch type	1-needle overlock
Max. sewing speed	6,000sti/min
Overedging width	10mm
Max. stitch length	7mm
Needle	DCx1 (#24)

Computer-controlled, High-speed, Lockstitch Buttonholing Sewing System



LBH-1790AN Series

The knife supports sewing lengths of 41mm at the maximum. Since the LBH-1795ANS is provided as standard with the 120 mm presser, it is capable of sewing 12-mm long buttonholes. The LBH-1795ANS is capable of sewing long buttonholes such as belt holes in car seats. In addition, it is applicable to the sewing of buttonholes in men's shirts (continuous sewing of two buttonholes and the use of two units of sewing machines), etc. The upper limit of the adjustment of the presser foot pressure has been expanded. The presser foot pressure is now digitally controlled. As a result, the machine acquires improved responsiveness to knit materials and car seats.



LBH-1790AN

LBH-1795AN (120mm buttonhole)



Management, browsing and editing of data can be carried out on the application software

A "Two-way" contactless communication for parameter adjustment data can be conducted with the sewing machine by a commercial Android terminal. This feature allows sewing machines in a sewing line to be uniformly set and status checked quickly, thereby contributing to stabilization in product quality. Control panel is standardized with USB ports, promising simplicity in data management and system updates.

*Android OS Version 6.0 is recommended to use JUKI Smart APP. (Operation is confirmed with respect to Versions 5.0 and later.) Contact JUKI distributor in your area for how to use the application software.

The sewing machine can be paired with equipment which supports NFC (Near Field Communication) only by holding the equipment over the sewing machine.



Optional part for 120mm buttonhole (From LBH-1790AN)

Optional part No.	Qty	Name of part
40006335	1	Presser arm 120
40008646	1	Presser foot 120 asm.
40008658	1	Presser foot 120
SS6060210SP	2	Screw
40028682	1	Close cam 120
40112711	1	Lifting plate 120
SM6050800SP	2	Screw
40006339	1	Cloth feed plate 120

Model name	LBH-1790AN	LBH-1795AN
Max. sewing speed	4,200sti/min	
Bartacking width	Max. 10mm	
Buttonhole length	Max. 41mm	Max. 120mm
Number of standard patterns	31 patterns	
Needle	DPx5 (#11J) #11J~#14J	

Control Box / Servomotor

SC-920/M51N Series

The new model control box SC-921 has been newly developed. The control box is resistant to voltage fluctuations, noise and vibration. The new model control box is provided with an energy-saving mode for the first time in a control box for sewing machines. Power consumption during standby period is further reduced. Considering convenience in setup and resource saving, both the volume and the weight of the control box has been reduced by 30% or more (as compared with the conventional control box SC-510).

High-torque AC servomotor M51N with an output of 750W has been adopted. The machine has excellent high-speed sewing performance and a strong cloth-penetrating force. The machine therefore demonstrates a broader range of applicability, from general fabric to extra heavy-weight materials.



SC-922/M51N

Model name	SC-921 / M51N	SC-922 / M51N
Motor type	AC servomotor	
Motor output	750W	
Power requirement	Single-phase 100~120V, 200~240V 3-phase 200~240V	
Power consumption	It demands on the operating conditions and installed machine head	
Number of input ports	10 (for optional inputs)	Max.24 ^{*1} (for optional inputs)
Number of output ports	8 (for optional outputs)	Max.32 ^{*1} (for optional outputs)
Number of basic programs ^{*2}	—	4
Number of basic programs steps	—	25 sewing steps (per 1 program)

Programming Software for Computer-controlled Sewing Machines

PM-1

This software is to input and edit sewing data of JUKI's latest sewing machines. Its versatile input functions allow to input sewing data of each electronic sewing machine model easily, accurately, and quickly. It supports high quality production with high added value by utilizing and creating original data for specific designs and applications.

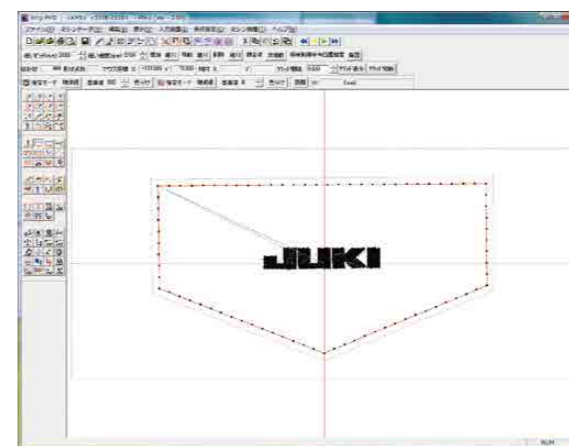

System Formation

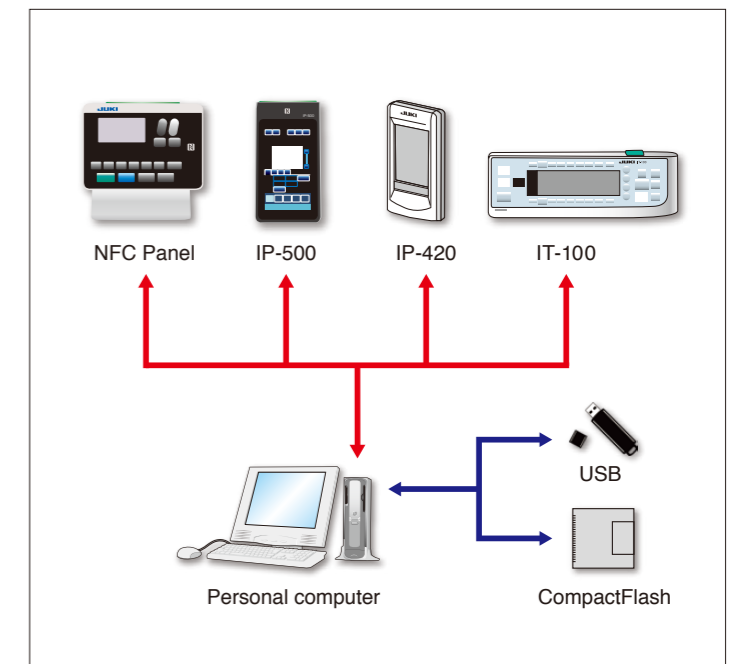

The sewing machine can be paired with equipment which supports NFC (Near Field Communication)

CompactFlash™ or CFA specification compatible media. "CompactFlash™" is a registered trademark of SanDisk Corporation, U.S.A. Other company names and product names/brand names are trademarks or registered trademarks of the respective companies.

JaNets

Juki advanced Network system



The productivity of your factory can always get better!

The first step to increasing productivity is to know the status of your sewing factory now.



*1 Idle waiting time and irregular tasks (e.g., thread changing) that divert the operator from sewing, preparing, and handling materials.
 *2 Operators working at different speeds. When your factory line is in good balance, your operators work at a uniform speed. When the balance is poor, a delay by one operator slows the next processes down the line.

JaNets is JUKI-provided IoT service to help customers increase productivity.



カタログPDF

With **JaNets** you can instantly find the parts of your factory you need to improve!



1
Seeing your line status in real time

Operation rates are clear to **See!**

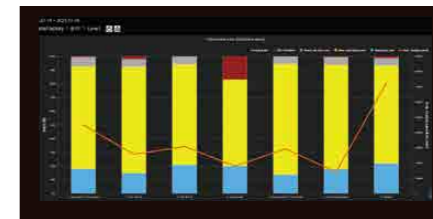

With JaNets, you can track operation metrics that you could only grasp with your senses before.

See sewing machine troubles instantly!

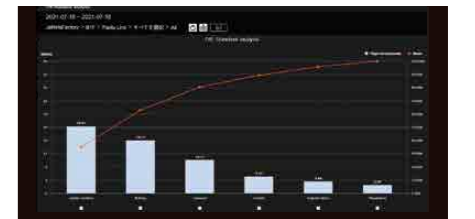

With JaNets, you can check which equipment has failed or caused irregular tasks, how often the failures and tasks have taken place, and for how long.

See processing times instantly!



With JaNets, you can check how much time an operator spends working on a garment.

See the progress of your line in real time!

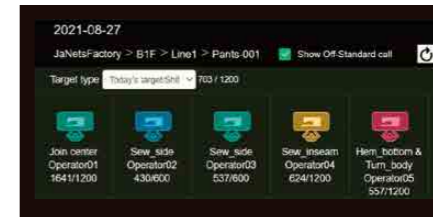

With JaNets, you can check your production progress without spending man-hours.

See your output quantities!

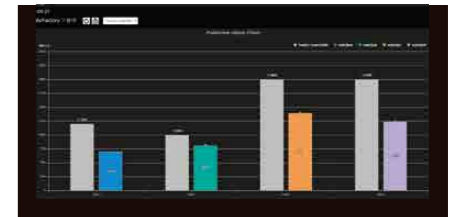

With JaNets, you can check the target/actual output quantity of each piece of equipment.



2
Improvement



3
Increased productivity!

Other advantages JaNets provides

Reduced waste

Factory operators with enhanced awareness

Enhanced responsiveness to labor shortages

Increase the productivity of your factory further!
 Why not get started with JUKI?

Contact JUKI to learn more about JaNets!



Website

Sewing machine inspection support system

JUKI-ShuHaRi Free registration

JUKI-ShuHaRi is a cloud-based "sewing machine inspection support system" consisting of the ShuHaRi app that supports operators with daily sewing machine inspections and the JUKI-ShuHaRi cloud service that allows maintenance managers to keep track of the sewing machine inspection status.

守破離 JUKI-ShuHaRi



Catalog PDF

How to use the JUKI-ShuHaRi sewing machine inspection support system



JUKI-ShuHaRi application form
https://www.juki.co.jp/industrial_j/service_j/shuhari_en/form.php

1. Enter required items in the usage application form on the JUKI website.
2. You will receive an email notification after your registration is completed.
3. The email provides the URL of the ShuHaRi app download page and the URL of the JUKI-ShuHaRi cloud service website.
4. Access the JUKI-ShuHaRi cloud service website from your personal computer to add presumed users in your factory. Users added afterwards will also receive email notifications.
5. Download the ShuHaRi app from the notification email and start using it.

Specifications

JUKI-ShuHaRi is a cloud-based system that can be used only by connecting your smartphone and PC to web browsers without installing software. No need to hassle with software installations. It should be noted that the factory's in-house Wi-Fi has to be used for communication within the factory.

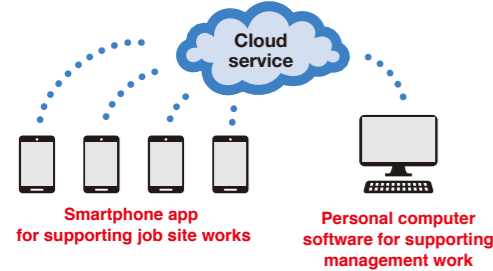

Support of the inspection work with the ShuHaRi app
 Operators in the production site may be in charge of daily inspections from tomorrow

Daily inspection

The sewing machine inspection takes only five minutes a day!

JUKI-ShuHaRi provides step-by-step instructions and important points with pictures to guide the operator along the way. The operator performs an inspection simply by following the instructions by the Shuhari app on his or her smartphone screen. The entire daily inspection takes only about five minutes per machine.

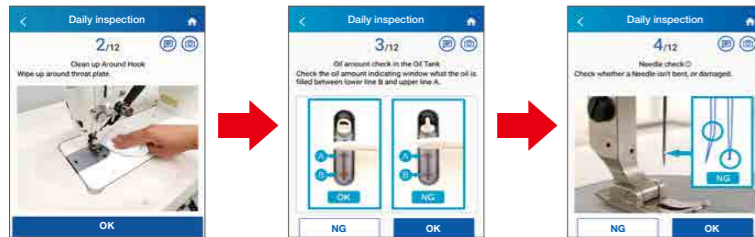

Periodical inspection

With the JUKI-ShuHaRi, the maintenance manager is able to carry out periodical inspections with ease

JUKI-ShuHaRi also supports the periodical inspection (once a month, three months or six months) that is carried out thoroughly by the maintenance manager. Many of sewing machine parts are consumable. It is therefore necessary to carry out periodical inspections in order to use the sewing machine for a long time with care. JUKI-ShuHaRi provides easy-to-understand guides about complicated inspection points of the sewing machine by the Shuhari app on the smartphone.

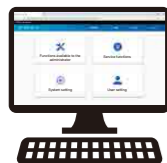

JUKI-ShuHaRi cloud service supports the maintenance management!
 All maintenance-related information are listed on tables to ensure easy maintenance management!

Sewing machine condition management

Condition of sewing machines in possession can be grasped real time

Inspection results, inspection history, parts-replacement aggregated data and ordering data can be seen and the accumulated information can be managed collectively on the personal computer. The efficiency of sewing machine management work rises dramatically.

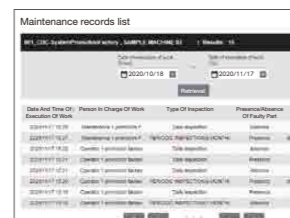

Management of spare parts and parts ordering

Order placement for parts and spare parts management are easily handled

The parts requested by operators with their ShuHaRi apps are collectively managed on a list. The parts requested by the operators are checked against the inventory to accurately grasp the required quantities, enabling requests for collective quotes from parts manufacturers. This contributes to the reduction of the occurrence of ordering mistakes and cost losses.

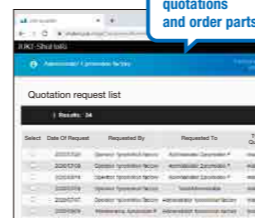

Easy to get quotations and order parts!

A human resource development program designed for the sewing industry

JUKI e-learning

JUKI e-learning



Catalog PDF

Learning the essential basics in the sewing industry

Many people are working in sewing-related industries around the world. Yet surprisingly few teaching materials have been developed to provide basic knowledge on sewing machines and sewing technology. Sewing machine operators therefore tend to be self-taught. The basic knowledge and skills acquired through **JUKI e-learning** can be immediately applied to daily work.



Gaining knowledge and experience from the online learning system

The **JUKI e-learning** program has been developed based on accumulated know-how and experience JUKI has acquired in technical training and management training over its long history. With easy-to-understand videos and narrations, training participants can seamlessly learn wide-ranging topics and skills. At the end of each chapter, the participant takes a test to confirm how well he/she understands the content.

Two different types of training are provided: Customers can select the type that suits your condition.

Learning individually! Individual training type

The individual training type is provided in a standard e-learning format. The training participant takes the individual e-learning courses using Individual PC, tablets or smartphone. The management user can manage his/her progress on the web.



The Individual e-learning training is recommended for the following customers

- Customers who can prepare an internet connection and device for every training participant.
- Customers who cannot provide group training because of heavy workloads and restrictions on gatherings during the coronavirus pandemic.
- Customers with many employees spread across multiple remote locations.

Individual training type [monthly fee system]

- Management fee**
- This is the fee for using the system with management user privileges. (At least one management user account is required for each application.)
 - With management user privileges, the progress of the participants (learning status, test scores, etc.) can be managed.
- Course learning period**
- Course fee**
- This is the fee for a training participant account. (The customer needs to create an account for every participant who takes the course.)
 - An individual ID is issued to each participant account. The participant can take the course as many times as he/she wants using his/her ID within the contract period.

Learning together! Group training type

The group training type is provided in a lecture format using **JUKI e-learning** materials. The group training is conducted with a large number of participants at the same time. To carry out group training, an instructor has to be prepared within the customer's company.



The Individual e-learning training is recommended for the following customers

- Customers who cannot provide separate Internet connections and devices for all of their training participants.
- Customers who want to provide all of the training in a single session to lower their costs.
- When a customer wants to provide training in an unsupported language, the customer's instructor will translate the e-learning materials to be used for the training.

Group training type [monthly fee system]

- Package fee**
- Contract period: At least one month
 - Number of participants: Unlimited



Examples of courses offered

Sewing Operator Training course

Japanese English Vietnamese

- Five chapters in total**
- Chapter 1** Apparel industry and apparel production
 - Chapter 2** Basic knowledge of needles, threads and sewing machines
 - Chapter 3** Operation and adjustment of lockstitch sewing machines
 - Chapter 4** Practice for lockstitch sewing machines
 - Chapter 5** Operation and adjustment of overlock sewing machines

★ Content for "practical exercises" can be found in Chapter 4. The training participant carries out hands-on practice using sewing practice sheets provided separately.

Basic Knowledge of Sewing - Lockstitching course

Japanese English Vietnamese

- Eight chapters in total**
- Introduction** six major elements of machine sewing
 - Chapter 1** Needle bar
 - Chapter 2** Hook
 - Chapter 3** Thread take-up
 - Chapter 4** Feed mechanism
 - Chapter 5** Presser foot
 - Chapter 6** Thread tension control system
 - Chapter 7** Summary

Additional courses will be provided, one by one!

● Contact the JUKI office in your area for information about non-supported languages.

As of January, 2022

To apply for the JUKI e-learning course, please use the QR code or URL below.



Application form

https://www.juki.co.jp/industrial_e/service_e/elearning/form.php

Plastic Bobbin

Fusion of function and strength. Reinforced plastic bobbin made in Japan with excellent durability and strength.



Catalog PDF

JUKI's new reinforced plastic bobbin will help you to solve the problem.

- It takes time to adjust the thread tension.
- Irregular stitches on light-weight materials.
- Stitching is unstable at high and low speeds.
- Loose stitches at the start of sewing.

Reduction of weight

Since the plastic bobbin is lighter than aluminum and iron, the thread tension is stable at a high level. Furthermore, it realizes beautiful stitching.

High durability

Since there is almost no rubbing inside the bobbin case, it is as durable as aluminum and iron.

Reduction of running idle

Thread bending that occurs after intermittent stitching or thread trimming is reduced. Needle thread tension at the start of sewing is reduced, and stitching is more stable. It also reduces the effect of the remaining bobbin thread amount on the thread tension.

Applicable model	Set part No. (10pcs.) Blue	Set part No. (10pcs.) Red	Set part No. (10pcs.) Yellow
For lockstitching	40244783	40245124	40245136
For 2-fold hook lockstitching	40244784	40245125	40245137
For 2-needle	40244785	40245126	40245138
For Zigzag/Button hole	40244786	40245127	40245139
For bar tacking	40244787	40245128	40245140
For computer-controlled cycle machine	40244788	40245129	40245141

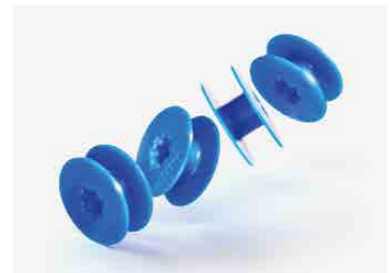

Pack of 10 bobbins

LK-1900 Shorter Thread remaining Kit

The thread trimming work in the bartacking process can be eliminated. It can be easily retrofitted and the productivity of the bartacking process increases.

The shorter-thread remaining function can be added to your sewing machine only by replacing with the dedicated throat plate kit. The length of the needle thread remaining on the back side of the material at the end of sewing is 2.5 mm or less on average.

It eliminates the need for thread trimming operation and gives soft and smooth feeling on the bartacking sections where directly contact skin such as underwear and other items.



Catalog PDF

Modified parts on a model basis

Applicable models	Sewing category	Part Number
LK-1900A / 1900AN / 1900B / 1900BN	Standard (S)	40193911
	Heavy-weight materials (H)	40194944
LK-1903A / 1903AN / 1903B / 1903BN	Button sewing	40193911
		40193915

- In the case of a button sewing machine, it is necessary to replace the shorter-thread remaining throat plate kit and the dedicated needle hole guide.
- All applicable models require special software

List of consumables

Part Name	Part Number
Moving knife (A)	40193905
Fixing knife (B)	40193912
Needle Hole Guide (C)	40193909 (S Spec)
	40193914 (H Spec)
	40193915 (Button sewing)

LK-1900 Instant Button Sewing Clamp Kit

This is a conversion kit from a bartacking machine to a button sewing machine.



Catalog PDF

Various button sizes can be supported. (Outer dia. 8 to 21 mm, thickness 1 to 4.5 mm can be sewn up to a hole spacing of 4.5 mm) Since the presser foot pressure is concentrated on the tip of the button clamp jaw lever, sewing defects due to displacement of the material are eliminated. Since the presser foot operates vertically, there is no deviation of the button center position due to the thickness of the material.

Bartacking process

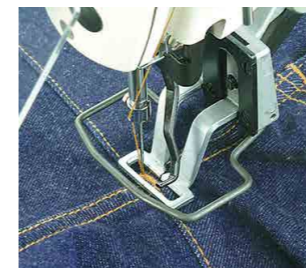

Applicable models

LK-1900BN LK-1900B
LK-1900AN LK-1900A

Button Sewing Clamp Kit

1 VERTICAL_BUTTON_ATTACHED_DEVICE



2 FEED_PLATE_A



Button sewing process



Standard accessory

3 4 Extra small thin button



5 6 Middle & Large thin button



7 8 9 Button floating dev.



10 Boss guide



11 For LK-1900A



Button Sewing Clamp Kit Parts List

No.	Part Number	Part Name
1	40205494	VERTICAL_BUTTON_ATTACHED_DEVICE
2	72002988	FEED_PLATE_A
3	72005816	SPRING_LEFT_B
4	72005817	SPRING_RIGHT_B
5	72005821	SPRING_LEFT_C_ASM
6	72005822	SPRING_RIGHT_C_ASM
7	72003011	BUTTON_RISING_BAR
8	SS6080340SP	SCREW 1/8-44 L=2.9
9	WP0370316SD	WASHER 3.7x8x0.3
10	MAZ15601000	GUIDE
11	72002987	LENGTHWISE_FEED_SENSOR_SLIT
12	40021011	SMALL_GAUGE

